

DrayTek

Vigor2130 Series High Speed Gigabit Router



Your reliable networking solutions partner

User's Guide

V 1.2

Vigor2130 Series High Speed Gigabit Router User's Guide

Version: 1.2

Firmware Version: V1.3.0.1

Date: 29/04/2010

Copyright Information

Copyright Declarations

Copyright 2010 All rights reserved. This publication contains information that is protected by copyright. No part may be reproduced, transmitted, transcribed, stored in a retrieval system, or translated into any language without written permission from the copyright holders.

Trademarks

The following trademarks are used in this document:

- Microsoft is a registered trademark of Microsoft Corp.
- Windows, Windows 95, 98, Me, NT, 2000, XP, Vista and Explorer are trademarks of Microsoft Corp.
- Apple and Mac OS are registered trademarks of Apple Inc.
- Other products may be trademarks or registered trademarks of their respective manufacturers.

Safety Instructions and Approval

Safety Instructions

- Read the installation guide thoroughly before you set up the router.
- The router is a complicated electronic unit that may be repaired only by authorized and qualified personnel. Do not try to open or repair the router yourself.
- Do not place the router in a damp or humid place, e.g. a bathroom.
- The router should be used in a sheltered area, within a temperature range of +5 to +40 Celsius.
- Do not expose the router to direct sunlight or other heat sources. The housing and electronic components may be damaged by direct sunlight or heat sources.
- Do not deploy the cable for LAN connection outdoor to prevent electronic shock hazards.
- Keep the package out of reach of children.
- When you want to dispose of the router, please follow local regulations on conservation of the environment.

Warranty

We warrant to the original end user (purchaser) that the router will be free from any defects in workmanship or materials for a period of two (2) years from the date of purchase from the dealer. Please keep your purchase receipt in a safe place as it serves as proof of date of purchase. During the warranty period, and upon proof of purchase, should the product have indications of failure due to faulty workmanship and/or materials, we will, at our discretion, repair or replace the defective products or components, without charge for either parts or labor, to whatever extent we deem necessary to restore the product to proper operating condition. Any replacement will consist of a new or re-manufactured functionally equivalent product of equal value, and will be offered solely at our discretion. This warranty will not apply if the product is modified, misused, tampered with, damaged by an act of God, or subjected to abnormal working conditions. The warranty does not cover the bundled or licensed software of other vendors. Defects which do not significantly affect the usability of the product will not be covered by the warranty. We reserve the right to revise the manual and online documentation and to make changes from time to time in the contents hereof without obligation to notify any person of such revision or changes.

Be a Registered Owner

Web registration is preferred. You can register your Vigor router via <http://www.draytek.com>.

Firmware & Tools Updates

Due to the continuous evolution of DrayTek technology, all routers will be regularly upgraded. Please consult the DrayTek web site for more information on newest firmware, tools and documents.

<http://www.draytek.com>

European Community Declarations

Manufacturer: DrayTek Corp.
Address: No. 26, Fu Shing Road, HuKou County, HsinChu Industrial Park, Hsin-Chu, Taiwan 303
Product: Vigor2130 Series Router

DrayTek Corp. declares that Vigor2130 Series of routers are in compliance with the following essential requirements and other relevant provisions of R&TTE Directive 1999/5/EEC.

The product conforms to the requirements of Electro-Magnetic Compatibility (EMC) Directive 2004/108/EC by complying with the requirements set forth in EN55022/Class B and EN55024/Class B.

The product conforms to the requirements of Low Voltage (LVD) Directive 2006/95/EC by complying with the requirements set forth in EN60950-1.

Regulatory Information

Federal Communication Commission Interference Statement

This equipment has been tested and found to comply with the limits for a Class B digital device, pursuant to Part 15 of the FCC Rules. These limits are designed to provide reasonable protection against harmful interference in a residential installation. This equipment generates, uses and can radiate radio frequency energy and, if not installed and used in accordance with the instructions, may cause harmful interference to radio communications. However, there is no guarantee that interference will not occur in a particular installation. If this equipment does cause harmful interference to radio or television reception, which can be determined by turning the equipment off and on, the use is encouraged to try to correct the interference by one of the following measures:

- Reorient or relocate the receiving antenna.
- Increase the separation between the equipment and receiver.
- Connect the equipment into an outlet on a circuit different from that to which the receiver is connected.
- Consult the dealer or an experienced radio/TV technician for help.

This device complies with Part 15 of the FCC Rules. Operation is subject to the following two conditions:

- (1) This device may not cause harmful interference, and
- (2) This device may accept any interference received, including interference that may cause undesired operation.

Please visit <http://www.draytek.com/user/AboutRegulatory.php>



This product is designed for 2.4GHz WLAN network throughout the EC region and Switzerland with restrictions in France. Please see the user manual for the applicable networks on your product.

Table of Contents

1

Preface	1
1.1 Web Configuration Buttons Explanation	1
1.2 LED Indicators and Connectors	2
1.2.1 For Vigor2130	2
1.2.2 For Vigor2130n	4
1.2.3 For Vigor2130Vn	6
1.3 Hardware Installation	8
Stand Installation	9
1.4 Printer Installation	10

2

Configuring Basic Settings	15
2.1 Two-Level Management	15
2.2 Accessing Web Page	15
2.3 Changing Password	16
2.4 Quick Start Wizard	18
2.4.1 Setting up the Password	18
2.4.2 Setting up the Time Zone	19
2.4.3 Setting up the Internet Connection	19
2.4.4 Setting up the Wireless Connection	24
2.4.5 Saving the Wizard Configuration	29
2.5 Online Status	29
2.6 Saving Configuration	30

3

User Mode Operation	31
3.1 WAN	31
3.1.1 Internet Access	33
3.1.2 Ports	39
3.1.3 3G Backup	40
3.2 LAN	41
3.2.1 General Setup	44
3.2.2 Ports	45
3.2.3 MAC Address Table	47
3.2.4 VLAN	48
3.2.5 Monitor Port	49
3.2.6 Static Route	50
3.2.7 Bind IP to MAC	51
3.3 NAT	53
3.3.1 Hardware NAT	53

3.3.2 Open Ports.....	54
3.3.3 DMZ Host.....	55
3.4 Bandwidth Management	56
3.4.1 Session Limit	56
3.4.2 Bandwidth Limit	57
3.4.3 Port Rate Control	59
3.4.4 QoS Control List	59
3.4.5 Ports Priority	64
3.4.6 QoS Statistics	65
3.5 Applications	67
3.5.1 Dynamic DNS	67
3.5.2 Schedule	68
3.5.3 IGMP Snooping	70
3.5.4 IGMP Status	70
3.5.5 UPnP Configuration	71
3.5.6 Wake On LAN	72
3.6 Wireless LAN	73
3.6.1 Basic Concepts.....	73
3.6.2 General Setup.....	75
3.6.3 Access Control.....	80
3.6.4 Station List	81
3.6.5 Access Point Discovery	82
3.7 USB Application	82
3.7.1 USB General Settings.....	82
3.7.2 FTP User Management	83
3.7.3 Disk Status.....	84
3.7.4 Disk Shares	84
3.8 IPv6	86
3.8.1 IPv6 WAN Setup.....	86
3.8.2 IPv6 LAN Setup	90
3.8.3 IPv6 Firewall Setup.....	91
3.8.4 IPv6 Routing	93
3.8.5 IPv6 Neighbour	94
3.8.6 IPv6 TSPC Status.....	94
3.9 User.....	97
3.9.1 User Configuration.....	97
3.10 System Maintenance.....	98
3.10.1 System Status.....	98
3.10.2 TR069	100
3.10.3 User Password	101
3.10.4 Configuration Backup	102
3.10.5 Syslog / Mail Alert	104
3.10.6 Time and Date	106
3.10.7 Management.....	107
3.10.8 Reboot System	108
3.10.9 Firmware Upgrade	108

4

Admin Mode Operation 109

4.1 WAN	109
---------------	-----

4.1.1 Internet Access	111
4.1.2 Ports.....	117
4.1.3 3G Backup	118
4.2 LAN	120
4.2.1 General Setup.....	122
4.2.2 Ports.....	123
4.2.3 MAC Address Table.....	125
4.2.4 VLAN.....	126
4.2.5 Monitor Port	127
4.2.6 Static Route	127
4.2.7 Bind IP to MAC	129
4.3 NAT	130
4.3.1 Hardware NAT	131
4.3.2 Open Ports.....	131
4.3.3 DMZ Host.....	133
4.4 Firewall	134
4.4.1 DoS Defense	134
4.4.2 Ports Configuration	135
4.4.3 Access Control List	137
4.5 Bandwidth Management	149
4.5.1 Session Limit	149
4.5.2 Bandwidth Limit	150
4.5.3 Port Rate Control.....	152
4.5.4 QoS Control List	152
4.5.5 Ports Priority	157
4.5.6 QoS Statistics	158
4.6 Applications	160
4.6.1 Dynamic DNS	160
4.6.2 Schedule.....	161
4.6.3 IGMP Snooping	163
4.6.4 IGMP Status	163
4.6.5 UPnP Configuration	164
4.6.6 Wake On LAN.....	166
4.7 VPN and Remote Access.....	166
4.7.1 Remote Access Control.....	167
4.7.2 PPTP Remote Dial-in.....	168
4.7.3 IPsec Remote Dial-in	169
4.7.4 Remote Dial-in Status.....	171
4.7.5 LAN to LAN.....	172
4.8 Wireless LAN	175
4.8.1 Basic Concepts.....	175
4.8.2 General Setup.....	176
4.8.3 Access Control.....	182
4.8.4 Station List	182
4.8.5 Access Point Discovery	183
4.9 USB Application	184
4.9.1 USB General Settings.....	184
4.9.2 FTP User Management	184
4.9.3 Disk Status.....	185
4.9.4 Disk Shares	186
4.10 IPv6	187

4.10.1 IPv6 WAN Setup.....	187
4.10.2 IPv6 LAN Setup.....	191
4.10.3 IPv6 Firewall Setup.....	192
4.10.4 IPv6 Routing.....	195
4.10.5 IPv6 Neighbour.....	196
4.10.6 IPv6 TSPC Status.....	196
4.11 User.....	199
4.11.1 User Configuration.....	199
4.12 System Maintenance.....	201
4.12.1 System Status.....	201
4.12.2 TR-069.....	202
4.12.3 System Password.....	204
4.12.4 User Password.....	204
4.12.5 Configuration Backup.....	205
4.12.6 Syslog/Mail Alert.....	207
4.12.7 Time and Date.....	209
4.12.8 Management.....	210
4.12.9 Reboot System.....	211
4.12.10 Firmware Upgrade.....	211
4.13 Diagnostics.....	212
4.13.1 Ping.....	212
4.13.2 Routing Table.....	213
4.13.3 System Log.....	214
4.13.4 Traffic Overview.....	214
4.13.5 Detailed Statistics.....	215
4.13.6 MAC Address Table.....	217
4.13.7 DHCP Table.....	219
4.13.8 Data Flow Monitor.....	220
4.13.9 Ports State.....	221

5

Trouble Shooting	223
5.1 Checking If the Hardware Status Is OK or Not.....	223
5.2 Checking If the Network Connection Settings on Your Computer Is OK or Not	224
5.3 Pinging the Router from Your Computer	226
5.4 Checking If the ISP Settings are OK or Not.....	227
5.5 Forcing Vigor Router into TFTP Mode for Performing the Firmware Upgrade	229
5.6 Backing to Factory Default Setting If Necessary	232
5.7 Contacting Your Dealer	233

1

Preface



The Vigor2130 series are the routers with high speed in data transmission through WAN port and LAN ports. With hardware NAT acceleration, the rate of Vigor2130 series can be greater than 900Mbps almost.

With the development of NGN (Next Generation Network), you may recently hear the news about FTTx deployment in your local area or even have already subscribed the unbundling last mile service (e.g. VDSL2) from local ITSP for FTTx. As adopting FTTx, the main question for end users is whether your legacy router could fully utilize its bandwidth or not.

For example, you purchase a 120 Mbps Internet connection from your ISP but your existing router cannot support 90 Mbps throughput. That's why DrayTek launches Vigor 2130 series – High speed Gigabit router, perfectly complied with VDSL2 environment including Vigor2130, Vigor2130n and Vigor2130Vn for speed-wanted customers. With high throughput performance and secured broadband connectivity provided by Vigor 2130 series, you can simultaneously engage these bandwidth-intensive applications, such as high-definition video streaming, online gaming, and Internet telephony / access.

1.1 Web Configuration Buttons Explanation

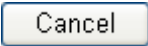
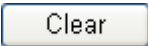
Several main buttons appeared on the web pages are defined as the following:

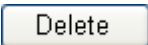
	Save and apply current settings.
	Cancel current settings and recover to the previous saved settings.
	Clear all the selections and parameters settings, including selection from drop-down list. All the values must be reset with factory default settings.
	Add new settings for specified item.
	Edit the settings for the selected item.
	Delete the selected item with the corresponding settings.

Note: For the other buttons shown on the web pages, please refer to Chapter 4 for detailed explanation.

1.2 LED Indicators and Connectors

Before you use the Vigor router, please get acquainted with the LED indicators and connectors first.

1.2.1 For Vigor2130

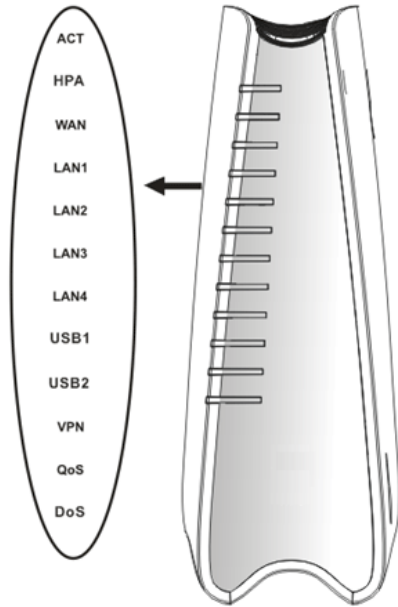

LED	Status	Explanation
ACT (Activity)	Blinking	The router is powered on and running normally.
	Off	The router is powered off.
HPA	On	Hardware NAT is enabled.
	Off	Hardware NAT is disabled.
WAN	On (Orange)	The port is connected with 100Mbps.
	On (Green)	The port is connected with 1000Mbps.
	Off	The port is disconnected.
	Blinking	It will blink while transmitting data.
LAN 1/2/3/4	On (Orange)	The port is connected with 100Mbps.
	On (Green)	The port is connected with 1000Mbps.
	Off	The port is disconnected.
USB1/2	Blinking	The data is transmitting.
	On	A USB device is connected and active.
VPN	On	The VPN tunnel is active.
QoS	On	The QoS function is active.
DoS	On	The DoS/DDoS function is active.
	Blinking	It will blink while detecting an attack.

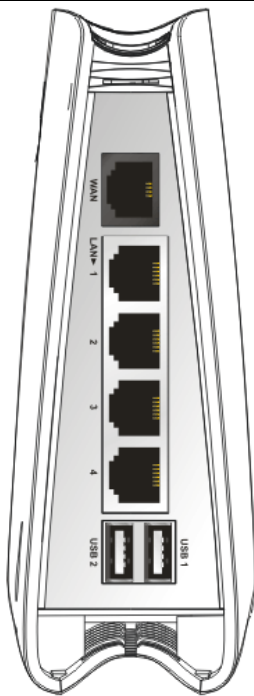

Interface	Description
WAN	Connector for accessing the Internet.
LAN (1/2/3/4)	Connectors for local networked devices.
USB (1/2)	Connector for USB storage device (Pen Driver/Mobile HD) or printer or 3G backup.

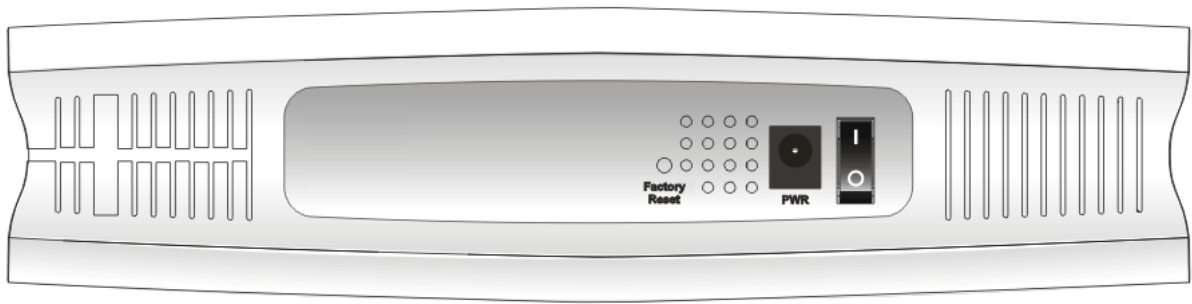

Interface	Description
Factory Reset	Restore the default settings. Usage: Turn on the router (ACT LED is blinking). Press the hole and keep for more than 5 seconds. When you see the ACT LED begins to blink rapidly than usual, release the button. Then the router will restart with the factory default configuration.
PWR	Connector for a power adapter.
ON/OFF	Power Switch.

1.2.2 For Vigor2130n

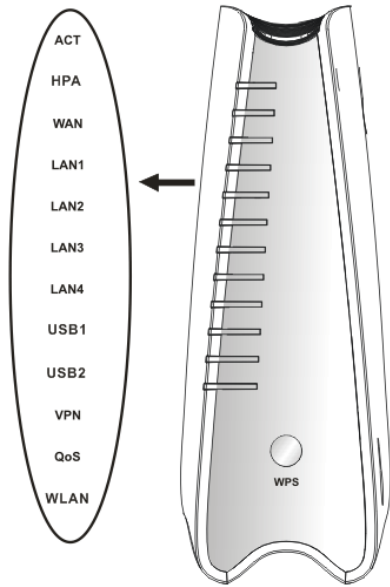

LED	Status	Explanation
ACT (Activity)	Blinking	The router is powered on and running normally.
	Off	The router is powered off.
HPA	On	Hardware NAT is enabled.
	Off	Hardware NAT is disabled.
WAN	On (Orange)	The port is connected with 100Mbps.
	On (Green)	The port is connected with 1000Mbps.
	Off	The port is disconnected.
	Blinking	It will blink while transmitting data.
LAN 1/2/3/4	On (Orange)	The port is connected with 100Mbps.
	On (Green)	The port is connected with 1000Mbps.
	Off	The port is disconnected.
	Blinking	The data is transmitting.
USB1/2	On	A USB device is connected and active.
	Blinking	The data is transmitting.
VPN	On	The VPN tunnel is active.
QoS	On	The QoS function is active.
WLAN	On	Wireless access point is ready.
	Blinking	It will blink while wireless traffic goes through.
WPS Button	On	Press this button for 2 seconds to wait for client device making network connection through WPS. When the LED lights up, the WPS connection will be on.
	Off	The WPS is off.
	Blinking	Waiting for wireless client sending requests for connection about two minutes.

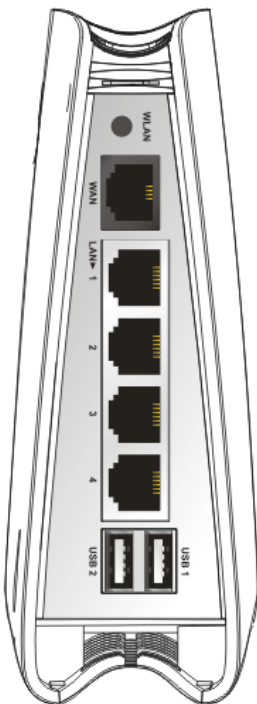

Interface	Description
WLAN	Press the button once to enable (WLAN LED on) or disable (WLAN LED off) wireless connection.
WAN	Connector for accessing the Internet.
LAN (1/2/3/4)	Connectors for local networked devices.
USB (1/2)	Connector for USB storage (Pen Driver /Mobile HD) or printer.

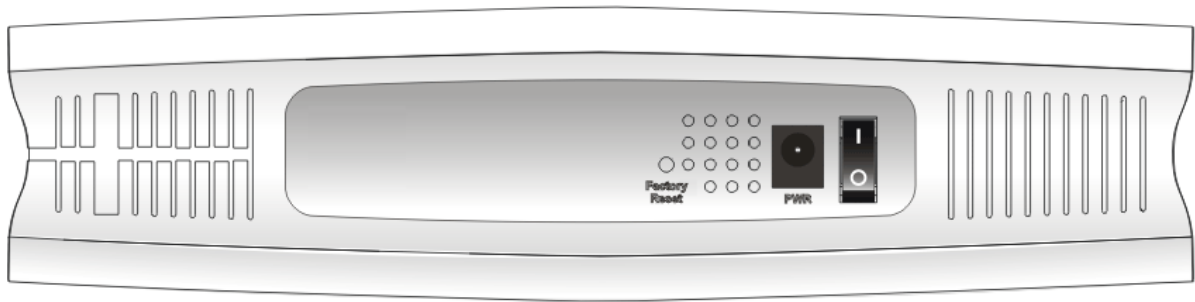

Interface	Description
Factory Reset	Restore the default settings. Usage: Turn on the router (ACT LED is blinking). Press the hole and keep for more than 5 seconds. When you see the ACT LED begins to blink rapidly than usual, release the button. Then the router will restart with the factory default configuration.
PWR	Connector for a power adapter.
ON/OFF	Power Switch.

1.2.3 For Vigor2130Vn

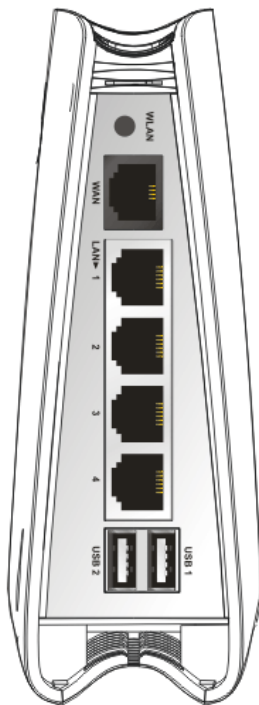
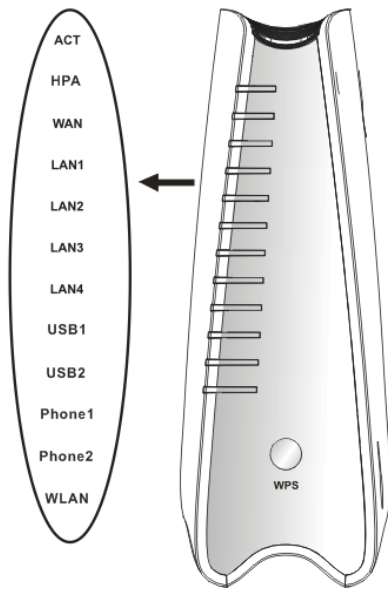

LED	Status	Explanation
ACT (Activity)	Blinking	The router is powered on and running normally.
	Off	The router is powered off.
HPA	On	Hardware NAT is enabled.
	Off	Hardware NAT is disabled.
WAN	On (Orange)	The port is connected with 100Mbps.
	On (Green)	The port is connected with 1000Mbps.
	Off	The port is disconnected.
	Blinking	It will blink while transmitting data.
LAN 1/2/3/4	On (Orange)	The port is connected with 100Mbps.
	On (Green)	The port is connected with 1000Mbps.
	Off	The port is disconnected.
	Blinking	The data is transmitting.
USB1/2	On	A USB device is connected and active.
	Blinking	The data is transmitting.
	Off	The data is not transmitting.
Phone1/ Phone2	On	The phone connected to this port is off-hook.
	Off	The phone connected to this port is on-hook.
	Blinking	A phone call comes.
WLAN	On	Wireless access point is ready.
	Blinking	It will blink while wireless traffic goes through.
WPS Button	On	Press this button for 2 seconds to wait for client device making network connection through WPS. When the LED lights up, the WPS connection will be on.
	Off	The WPS is off.
	Blinking	Waiting for wireless client sending requests for connection about two minutes.

Interface	Description
WLAN	Press the button once to enable (WLAN LED on) or disable (WLAN LED off) wireless connection.
WAN	Connector for accessing the Internet.
LAN (1/2/3/4)	Connectors for local networked devices.
USB (1/2)	Connector for USB storage (Pen Driver/Mobile HD) or printer.

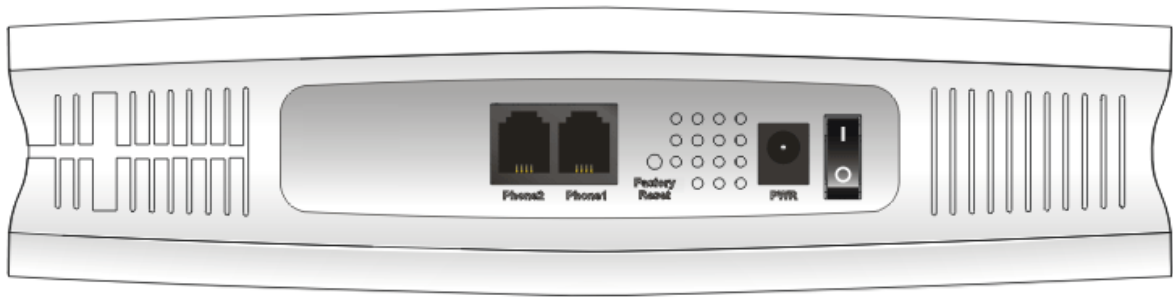

Interface	Description
Phone2/Phone1	Connector of analog phone for VoIP communication.
Factory Reset	Restore the default settings. Usage: Turn on the router (ACT LED is blinking). Press the hole and keep for more than 5 seconds. When you see the ACT LED begins to blink rapidly than usual, release the button. Then the router will restart with the factory default configuration.
PWR	Connector for a power adapter.
ON/OFF	Power Switch.

1.3 Hardware Installation

Before starting to configure the router, you have to connect your devices correctly.

1. Connect Line port to land line jack with a RJ-11 cable (Vn model).
2. Connect this device to a modem with an Ethernet cable.
3. Connect one port of 4-port switch to your computer with a RJ-45 cable. This device allows you to connect 4 PCs directly.
4. Connect Phone port to a conventional analog telephone.
5. Connect detachable antennas to the router for Vigor2130 series (n model).
6. Connect one end of the power cord to the power port of this device. Connect the other end to the wall outlet of electricity.
7. Power on the router.
8. Check the **ACT** and **WAN, LAN** LEDs to assure network connections.

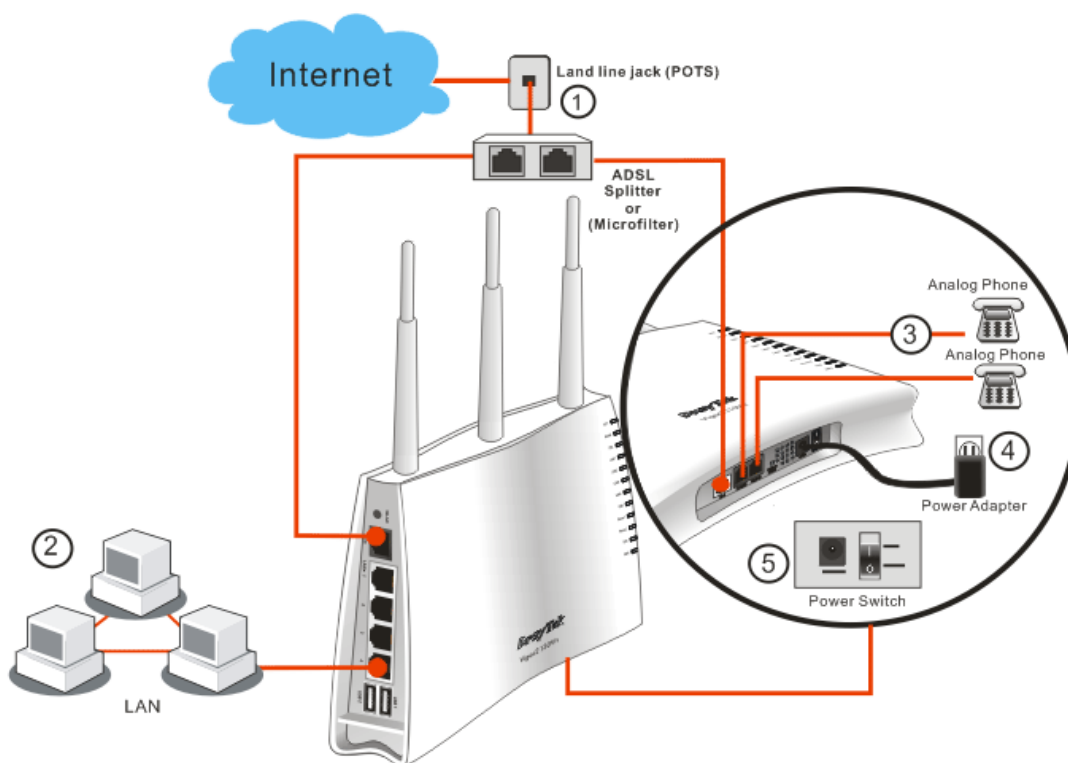

(For the detailed information of LED status, please refer to section 1.1.)

Caution:

1. Each of the Phone ports can be connected to an analog phone only. Do not connect the phone ports to the land line jack. Such connection might damage your router.
2. When the power is shutdown, VoIP phone will be disconnected. However, a phone set connected to Phone 2 port can be used as the traditional telephone for the line will be guided to land line jack via the router (loop through).

Stand Installation

The Vigor2130 must be placed erectly. Therefore you have to install a stand onto the router to make it standing firmly. Please follow the figures listed below to finish the installation.

①

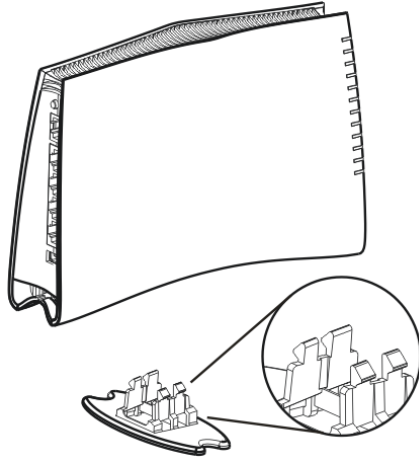

②

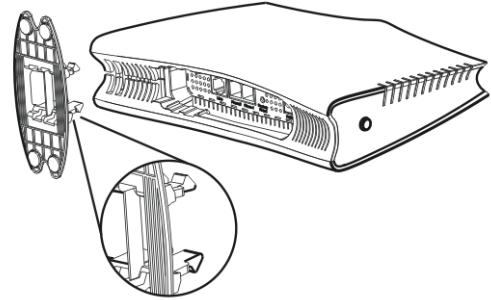

③

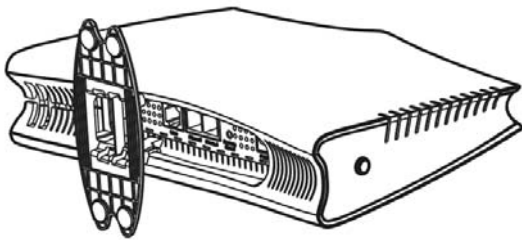

④

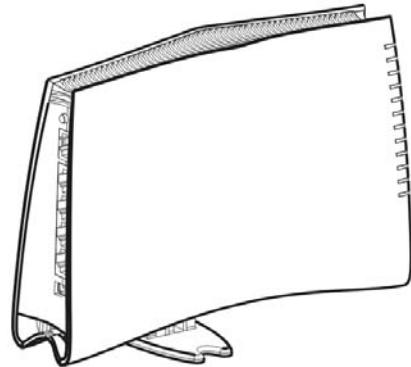

1.4 Printer Installation

You can install a printer onto the router for sharing printing. All the PCs connected this router can print documents via the router. The example provided here is made based on Windows XP/2000. For Windows 98/SE/Vista, please visit www.draytek.com.

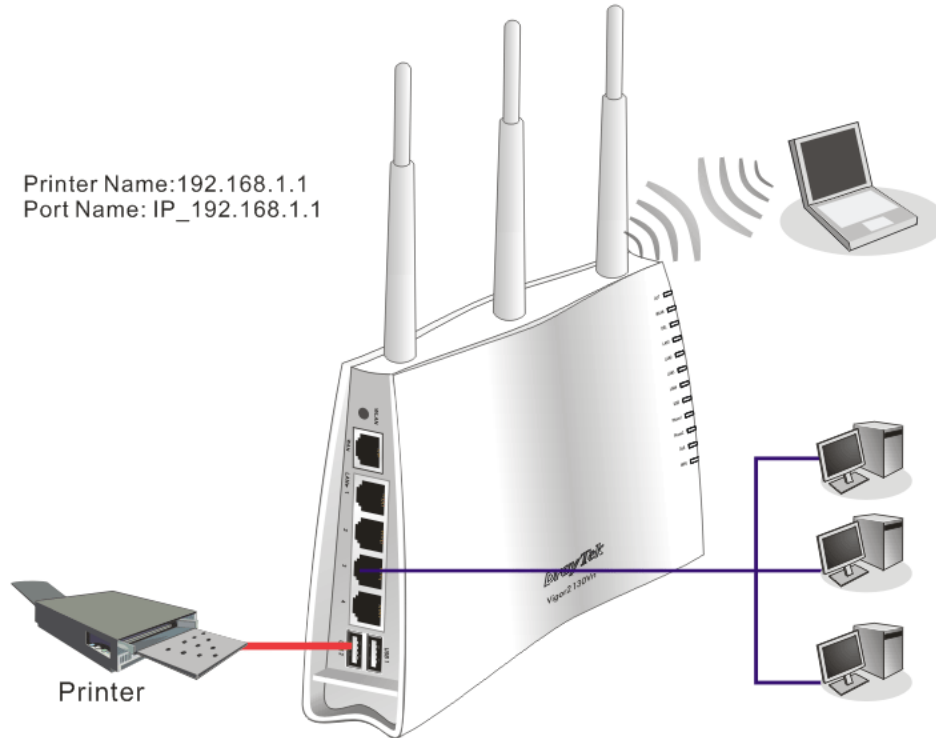

Before using it, please follow the steps below to configure settings for connected computers (or wireless clients).

1. Connect the printer with the router through USB/parallel port.
2. Open **Start->Settings-> Printer and Faxes**.

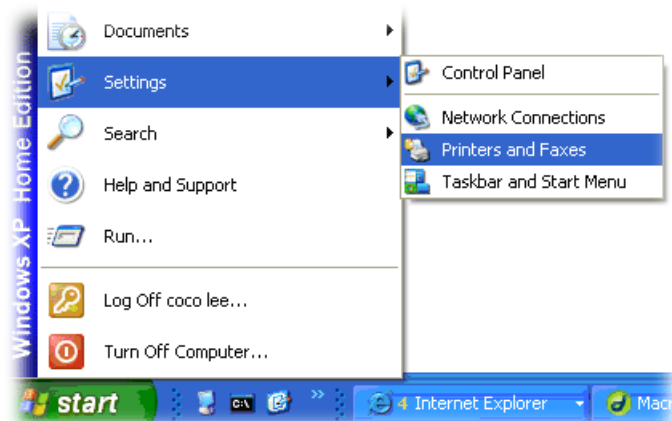

3. Open **File->Add a New Computer**. A welcome dialog will appear. Please click **Next**.

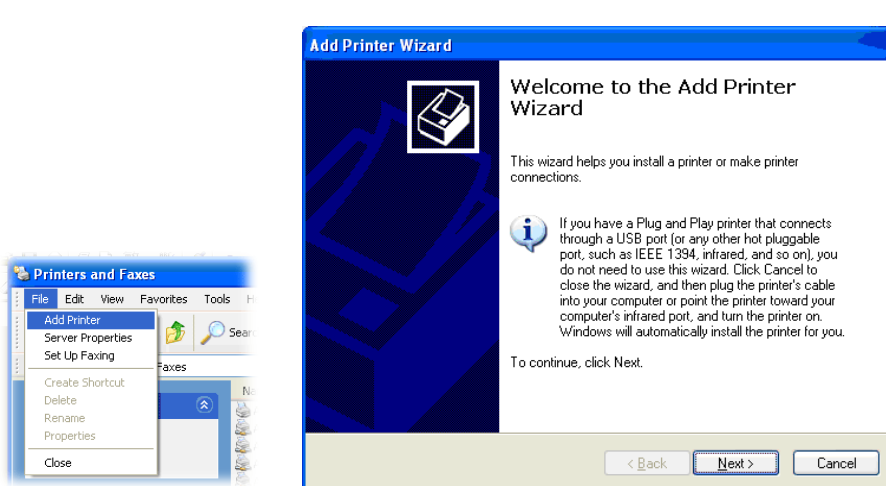

4. Click Local printer attached to this computer and click Next.



5. In this dialog, choose **Create a new port Type of port** and use the drop down list to select **Standard TCP/IP Port**. Click Next.

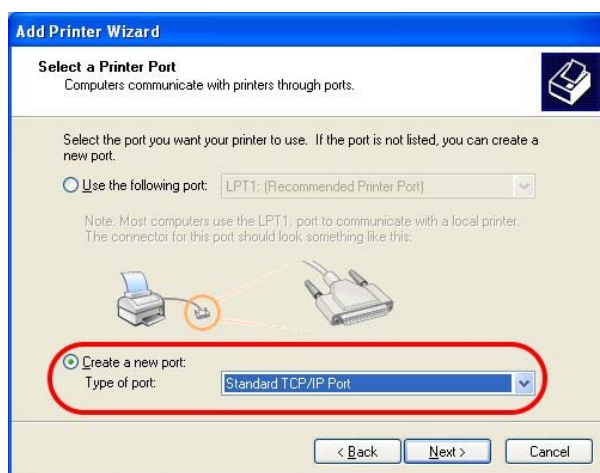

- In the following dialog, type **192.168.1.1** (router's LAN IP) in the field of **Printer Name or IP Address** and type **IP_192.168.1.1** as the port name. Then, click **Next**.

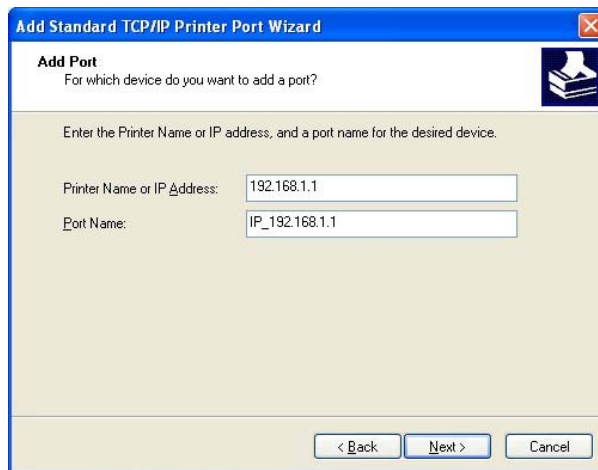

- Click **Standard** and choose **Generic Network Card**.

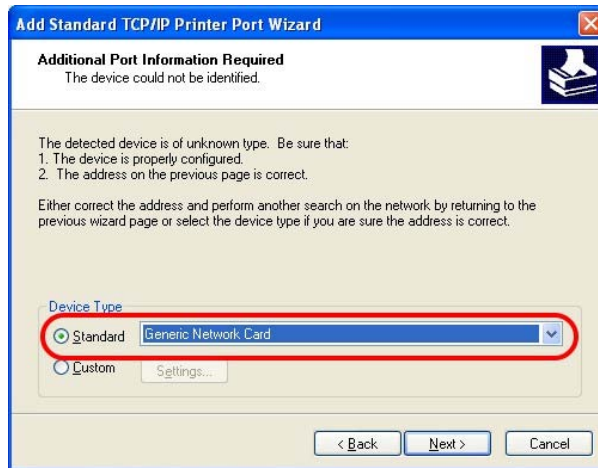

- Then, in the following dialog, click **Finish**.



9. Now, your system will ask you to choose right name of the printer that you installed onto the router. Such step can make correct driver loaded onto your PC. When you finish the selection, click **Next**.

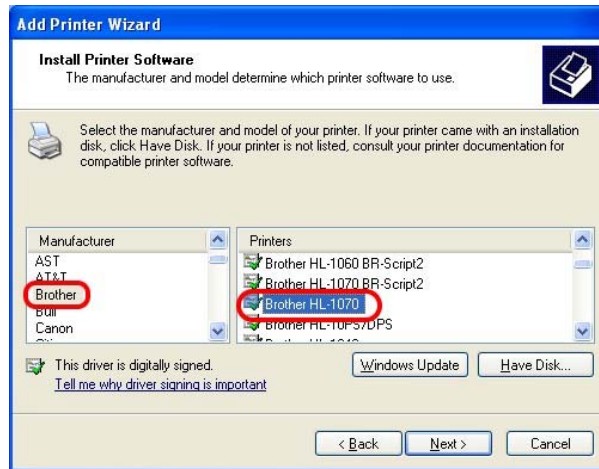

10. For the final stage, you need to go back to **Control Panel-> Printers** and edit the property of the new printer you have added.

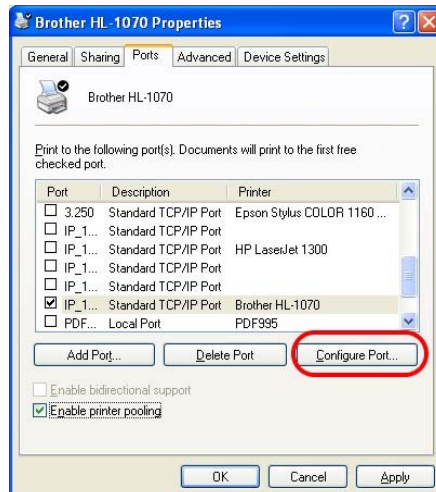

11. Select "**LPR**" on Protocol, type **p1** (number 1) as Queue Name. Then click **OK**. Next please refer to the red rectangle for choosing the correct protocol and UPR name.

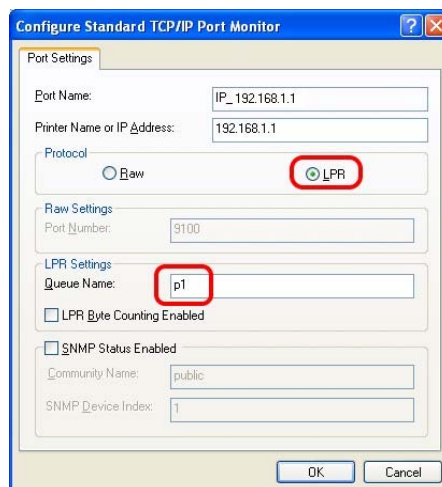

The printer can be used for printing now. Most of the printers with different manufacturers are compatible with vigor router.

Note 1: Some printers with the fax/scanning or other additional functions are not supported. If you do not know whether your printer is supported or not, please visit www.draytek.com to find out the printer list. Open **Support >FAQ**; find out the link of **Printer Server** and click it; then click the **What types of printers are compatible with Vigor router?** link.

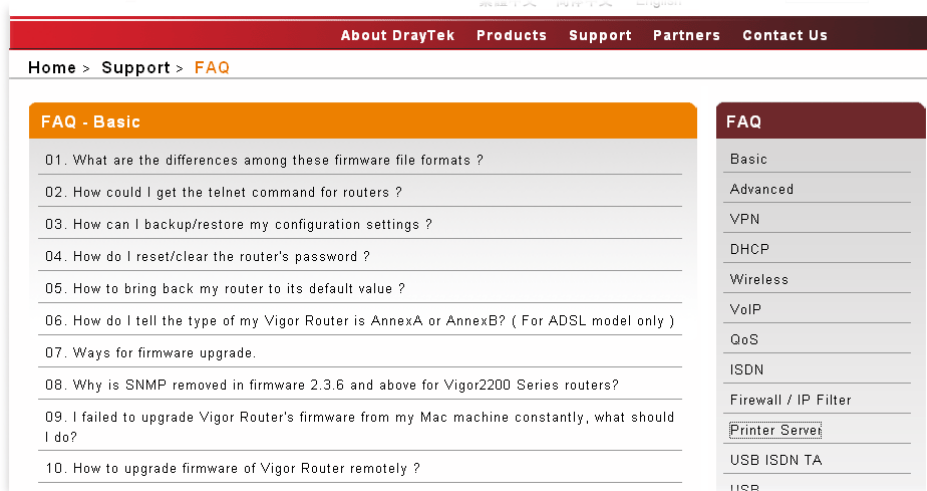

FAQ - Printer Server

01. How do I configure LPR printing on Windows2000/XP ?
02. How do I configure LPR printing on Windows98/Me ?
03. How do I configure LPR printing on Linux boxes ?
04. Why there are some strange print-out when I try to print my documents through Vigor210 4P / 2300's print server?
05. **What types of printers are compatible with Vigor router?**
06. What are the limitations in the USB Printer Port of Vigor Router ?
07. What is the printing buffer size of Vigor Router ?
08. How do I configure LPR printing on Mac OSX ?
09. How do I configure LPR printing on My Windows Vista ?

Note 2: Vigor router supports printing request from computers via LAN ports but not WAN port.

2

Configuring Basic Settings

For using the router properly, it is necessary for you to change the password of web configuration for security and adjust primary basic settings.

2.1 Two-Level Management

This chapter explains how to setup a password for an administrator/user and how to adjust basic/advanced settings for accessing Internet successfully.

For user mode operation, do not type any word on the window and click **Login** for the simple web pages for configuration. Yet, for admin mode operation, please type “admin/admin” on Username/Password and click **Login** for full configuration.

2.2 Accessing Web Page

1. Make sure your PC connects to the router correctly.



Notice: You may either simply set up your computer to get IP dynamically from the router or set up the IP address of the computer to be the same subnet as **the default IP address of Vigor router 192.168.1.1**. For the detailed information, please refer to the later section - Trouble Shooting of the guide.

2. Open a web browser on your PC and type **http://192.168.1.1**. The following window will be open to ask for username and password.

3. For user mode operation, do not type any word on the window and click **Login** for the simple web pages for configuration. Yet, for admin mode operation, please type “admin/admin” on Username/Password and click **Login** for full configuration.



Notice: If you fail to access to the web configuration, please go to “Trouble Shooting” for detecting and solving your problem.

4. The web page can be logged out according to the chosen condition. The default setting is **Auto Logout**, which means the web configuration system will logout after 5 minutes without any operation. Change the setting for your necessity.

2.3 Changing Password

No matter user mode operation or admin mode operation, please change the password for the original security of the router.

1. Open a web browser on your PC and type **http://192.168.1.1**. A pop-up window will open to ask for username and password.
2. Please type “admin/admin” on Username/Password for admin mode. Otherwise, do not type any word (both username and password are Null for user mode) on the window and click **Login** on the window.
3. Now, the **Main Screen** will appear.

Vigor2130 Series
High Speed Gigabit Router

DrayTek

Auto Logout

- Quick Start Wizard
- Online Status
- WAN
- LAN
- NAT
- Firewall
- Bandwidth Management
- Applications
- VPN and Remote Access
- Wireless LAN
- USB Application
- IPv6
- User
- System Maintenance
- Diagnostics

Logout

All Rights Reserved.

Admin mode

System Status

Auto-refresh Refresh

Model : Vigor2130n
Firmware Version : v1.3.0.1
Build Date/Time : Wed Apr 14 15:28:51 CST 2010
System Date : Mon Apr 26 05:33:52 2010
System Uptime : 0d 02:17:01

System	
CPU Usage	: 0%
Memory Usage	: 22676K / 62796K (36.11%)

LAN	
MAC Address	: 00:50:7F:C8:6A:FC
IP Address	: 192.168.1.1
IP Mask	: 255.255.255.0
IPv6 Address	: 2000::1/64 (Global)
IPv6 Address	: fe80::200:ff:fe00:0/64 (Link)
DHCP Server	: Yes

WAN	
Connection Mode	: Static
Link Status	: Connected
MAC Address	: 00:50:7F:C8:6A:FD
IP Address	: 172.16.3.102
IP Mask	: 255.255.0.0
IPv6 Address	: fe80::250:7fff:fec8:6afd/64 (Link)
Default Gateway	: 172.16.1.1
Primary DNS	: 168.95.1.1
Secondary DNS	:

Wireless	
MAC Address	: 00:50:7F:C8:6A:FC
SSID	: DrayTek
Channel	: 11

Main screen for admin mode operation (full configuration)

Vigor2130 Series
High Speed Gigabit Router

DrayTek

Auto Logout

- Quick Start Wizard
- Online Status
- WAN
- LAN
- NAT
- Bandwidth Management
- Applications
- Wireless LAN
- USB Application
- IPv6
- User
- System Maintenance

Logout

All Rights Reserved.

User mode

System Status

Auto-refresh Refresh

Model : Vigor2130n
Firmware Version : v1.3.0.1
Build Date/Time : Wed Apr 14 15:28:51 CST 2010
System Date : Mon Apr 26 05:32:04 2010
System Uptime : 0d 02:15:13

System	
CPU Usage	: 0%
Memory Usage	: 22668K / 62796K (36.1%)

LAN	
MAC Address	: 00:50:7F:C8:6A:FC
IP Address	: 192.168.1.1
IP Mask	: 255.255.255.0
IPv6 Address	: 2000::1/64 (Global)
IPv6 Address	: fe80::200:ff:fe00:0/64 (Link)
DHCP Server	: Yes

WAN	
Connection Mode	: Static
Link Status	: Connected
MAC Address	: 00:50:7F:C8:6A:FD
IP Address	: 172.16.3.102
IP Mask	: 255.255.0.0
IPv6 Address	: fe80::250:7fff:fec8:6afd/64 (Link)
Default Gateway	: 172.16.1.1
Primary DNS	: 168.95.1.1
Secondary DNS	:

Wireless	
MAC Address	: 00:50:7F:C8:6A:FC
SSID	: DrayTek
Channel	: 11

Main screen for user mode operation (simple configuration)

Note: The home page will change slightly in accordance with the type of the router you have.

- Go to **System Maintenance** page and choose **System Password/User Password**.

System Maintenance >> System Password

System Password

Old Password	<input type="text"/>
New Password	<input type="text"/>
Confirm New Password	<input type="text"/>

Or

System Maintenance >> User Password

User Password

Old Password	<input type="text"/>
New Password	<input type="text"/>
Confirm New Password	<input type="text"/>

- Type **New Password** in New Password and Confirm New Password fields. Then click **OK** to continue.
- Now, the password has been changed. Next time, use the new password to access the Web Configurator for this router.

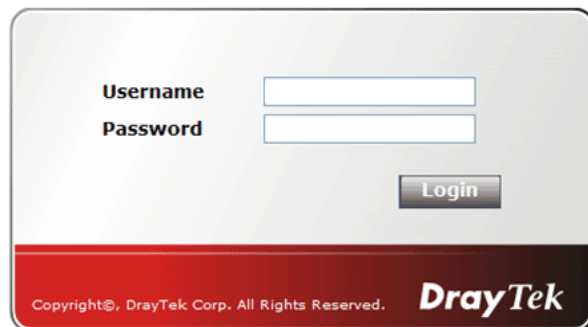

The image shows a login screen with a light gray background and a red footer. It features two input fields: 'Username' and 'Password'. Below the 'Password' field is a 'Login' button. The footer contains the text 'Copyright©, DrayTek Corp. All Rights Reserved.' and the 'DrayTek' logo.

2.4 Quick Start Wizard



Notice: Quick Start Wizard for user mode operation is the same as for admin mode operation.

If your router can be under an environment with high speed NAT, the configuration provide here can help you to deploy and use the router quickly. The first screen of **Quick Start Wizard** is welcome page, please click **Next**.

Quick Start Wizard

Welcome to the Quick Start Wizard!

The next steps will guide you through a basic setup of the device.
If you want more advanced setup you should consider setting the device up manually.

- Step 1: Setup the Password
- Step 2: Setup the Timezone
- Step 3: Setup the Internet connection (WAN)
- Step 4: Setup the Wireless (Wi-Fi)
- Step 5: Save the configuration

< Back

Next >

Finish

Cancel

2.4.1 Setting up the Password

The first screen of **Quick Start Wizard** is entering login password. After typing the password, please click **Next**.

Quick Start Wizard

System Password

New Password

Confirm Password

< Back

Next >

Finish

Cancel

2.4.2 Setting up the Time Zone

On the next page as shown below, please select the Time Zone for the router installed and specify the NTP server(s). Then click **Next** for next step.

Quick Start Wizard

Time Configuration

Time Zone	Unknown
NTP Servers	
Delete	0.openwrt.pool.ntp.org
Delete	1.openwrt.pool.ntp.org
Delete	2.openwrt.pool.ntp.org
Delete	3.openwrt.pool.ntp.org
Add NTP server	

< Back Next > Finish Cancel

2.4.3 Setting up the Internet Connection

On the next page as shown below, please select the appropriate connection type according to the information from your ISP. There are five types offered in this page. Each connection type will bring out different web page.

Quick Start Wizard

WAN IP Configuration

Connection Type	DHCP
Clone MAC Address	<input type="checkbox"/>
Enable	<input type="checkbox"/>

< Back Next > Finish Cancel

Static IP

You will receive a fixed public IP address or a public subnet, namely multiple public IP addresses from your DSL or Cable ISP service providers. In most cases, a Cable service provider will offer a fixed public IP, while a DSL service provider will offer a public subnet. If you have a public subnet, you could assign an IP address or many IP address to the WAN interface.

Quick Start Wizard

WAN IP Configuration

Connection Type	Static IP
Static IP	
IP Address	172.16.3.229
Subnet Mask	255.255.0.0
Gateway	172.16.3.4
Primary DNS Server	0.0.0.0
Secondary DNS Server	0.0.0.0
Clone MAC Address	
Enable	<input type="checkbox"/>

< Back Next > Finish Cancel

IP Address	Type the IP address.
Subnet Mask	Type the subnet mask.
Gateway	Type the gateway IP address.
Primary DNS Server	Type in the primary IP address for the router
Secondary DNS Server	Type in secondary IP address for necessity in the future.
Enable	The router will detect the MAC address automatically. Or, check the box to enable MAC address cloning.
Clone MAC Address	It is available when the box of Enable is checked. Click Clone PC Address. The result will be displayed in the field of MAC Address.

Enable	<input checked="" type="checkbox"/>	Clone MAC Address
MAC Address		00-0E-A6-2A-D5-A1

After finishing the settings here, please click **Next**.

DHCP

It is not necessary for you to type any IP address manually. Simply choose this type and the system will obtain the IP address automatically from DHCP server.

The screenshot shows the 'Quick Start Wizard' interface. Under the 'WAN IP Configuration' section, the 'Connection Type' is set to 'DHCP'. Below this, there is a section for 'Clone MAC Address' with a checkbox labeled 'Enable' which is currently unchecked. At the bottom of the wizard, there are four buttons: '< Back', 'Next >', 'Finish', and 'Cancel'.

Enable

The router will detect the MAC address automatically. Or, check the box to enable MAC address cloning.

Clone MAC Address

It is available when the box of Enable is checked. Click Clone PC Address. The result will be displayed in the field of MAC Address.

This screenshot shows the configuration options for cloning a MAC address. The 'Enable' checkbox is checked with a green checkmark. A 'Clone MAC Address' button is present. Below it, the 'MAC Address' field displays the value '00-0E-A6-2A-D5-A1'.

After finishing the settings here, please click **Next**.

PPPoE

PPPoE stands for **Point-to-Point Protocol over Ethernet**. It relies on two widely accepted standards: PPP and Ethernet. It connects users through an Ethernet to the Internet with a common broadband medium, such as a single DSL line, wireless device or cable modem. All the users over the Ethernet can share a common connection.

PPPoE is used for most of DSL modem users. All local users can share one PPPoE connection for accessing the Internet. Your service provider will provide you information about user name, password, and authentication mode.

If your ISP provides you the **PPPoE** connection, please select **PPPoE** for this router. The following page will be shown:

Quick Start Wizard

WAN IP Configuration

Connection Type	PPPoE ▾
PPPoE	
Username	<input type="text"/>
Password	<input type="text"/>
Redial Policy	Connect on Demand ▾
Idle Time out	<input type="text"/>
MTU Size	<input type="text"/>
Clone MAC Address	
Enable	<input checked="" type="checkbox"/> <input type="button" value="Clone MAC Address"/>
MAC Address	<input type="text"/>

- User Name** Assign a specific valid user name provided by the ISP.
- Password** Assign a valid password provided by the ISP.
- Redial Policy** If you want to connect to Internet all the time, you can choose **Always On**. Otherwise, choose **Connect on Demand**.

- Idle Time Out** Set the timeout for breaking down the Internet after passing through the time without any action. The unit is seconds. The range is XX ~ XX.
- MTU Size** It means Max Transmit Unit for packet. The default setting is 1442.
- Enable** The router will detect the MAC address automatically. Or, check the box to enable MAC address cloning.
- Clone MAC Address** It is available when the box of Enable is checked. Click Clone PC Address. The result will be displayed in the field of MAC Address.

Enable	<input checked="" type="checkbox"/> <input type="button" value="Clone MAC Address"/>
MAC Address	<input type="text" value="00-0E-A6-2A-D5-A1"/>

After finishing the settings here, please click **Next**.

PPTP/L2TP

if you click PPTP/L2TP as the protocol, please manually enter the Username/Password provided by your ISP and all the required information.

Quick Start Wizard

WAN IP Configuration

Connection Type	PPTP
PPTP Settings	
Username	<input type="text"/>
Password	<input type="password"/>
Server Address	0.0.0.0
WAN IP Network Settings	Static IP
IP Address	172.16.3.102
Subnet Mask	255.255.0.0
Redial Policy	Connect on Demand
Idle Time out	<input type="text"/>
MTU Size	<input type="text"/>
Clone MAC Address	
Enable	<input checked="" type="checkbox"/> Clone MAC Address
MAC Address	<input type="text"/>

< Back Next > Finish Cancel

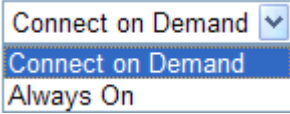
- User Name** Assign a specific valid user name provided by the ISP.
- Password** Assign a valid password provided by the ISP.
- Server Address** Specify the IP address of the PPTP server.
- WAN IP Network Settings** You can choose Static IP or DHCP as WAN IP network setting.
- IP Address** Type the IP address if you choose Static IP as the WAN IP network setting.
- Subnet Mask** Type the subnet mask if you chose Static IP as the WAN IP.
- Redial Policy** If you want to connect to Internet all the time, you can choose **Always On**. Otherwise, choose **Connect on Demand**.
- 
- Idle Time Out** Set the timeout for breaking down the Internet after passing through the time without any action. The unit is seconds. The range is XX ~ XX.
- MTU Size** It means Max Transmit Unit for packet. The default setting is 1442.
- Enable** The router will detect the MAC address automatically. Or, check the box to enable MAC address cloning.

Clone MAC Address

It is available when the box of Enable is checked. Click Clone PC Address. The result will be displayed in the field of MAC Address.

Enable	<input checked="" type="checkbox"/>	Clone MAC Address
MAC Address		00-0E-A6-2A-D5-A1

After finishing the settings here, please click **Next**.

2.4.4 Setting up the Wireless Connection

Now, you have to set up the wireless connection. For the user of Vigor2130, please skip this step.

Quick Start Wizard

Wireless System Configuration

Enable Wireless LAN	<input checked="" type="checkbox"/>
SSID Broadcast	Show
SSID	DrayTek
Wireless Security Configuration	
Encryption	None

< Back Next > Finish Cancel

Enable Wireless LAN

Check the box to enable the wireless function.

SSID Broadcast

Choose **Show** to make the SSID being seen by wireless clients. Choose **Hide** to prevent from wireless sniffing and make it harder for unauthorized clients or STAs to join your wireless LAN.

SSID

It means the identification of the wireless LAN. SSID can be any text numbers or various special characters. The default SSID is "DrayTek". We suggest you to change it.

Encryption

Select an appropriate encryption mode to improve the security and privacy of your wireless data packets.

None	▼
None	
WEP	
WPA-PSK	
WPA-RADIUS	
WPS	

Each encryption mode will bring out different web page and ask you to offer additional configuration.

WEP

If you choose WEP as the security configuration, you have to specify encryption key (Key 1 ~ Key 4) and authentication mode (open or shared). All wireless devices must support the same

WEP encryption bit size and have the same key.

Quick Start Wizard

Wireless System Configuration

Enable Wireless LAN	<input checked="" type="checkbox"/>
SSID Broadcast	Show <input type="button" value="v"/>
SSID	DrayTek <input type="text"/>
Wireless Security Configuration	
Encryption	WEP <input type="button" value="v"/>
WEP Configuration	
Default Key	Key1 <input type="button" value="v"/>
Key1	<input type="text"/>
Key2	<input type="text"/>
Key3	<input type="text"/>
Key4	<input type="text"/>
Authentication Mode	OPEN <input type="button" value="v"/>

Four keys can be entered here, but only one key can be selected at a time. The keys can be entered in ASCII or Hexadecimal. Choose the key you wish to use by using the Default Key drop down list.

WPA-PSK

If you choose WPA-PSK as the security configuration, you have to specify WPA mode, algorithm and pre-shared key.

Quick Start Wizard

Wireless System Configuration

Enable Wireless LAN	<input checked="" type="checkbox"/>
SSID Broadcast	Show
SSID	DrayTek
Wireless Security Configuration	
Encryption	WPA-PSK
WPA-PSK Configuration	
Type	WPA
WPA Algorithm	TKIP
WPA Pre-Shared Key	

< Back Next > Finish Cancel

Type The WPA encrypts each frame transmitted from the radio using the key, which either PSK (Pre-Shared Key) entered manually in this field below or automatically negotiated via 802.1x authentication. Select WPA, WPA2 or Auto as WPA mode.

Auto(WPA or WPA2)
WPA
WPA2
Auto(WPA or WPA2)

WPA Algorithm

Choose the WPA algorithm, TKIP, AES or Auto.

AES
TKIP
AES
Auto(TKIP or AES)

WPA Pre-shared Key

The keys can be entered in ASCII or Hexadecimal. Check the key you wish to use.

WPA- RADIUS

Remote Authentication Dial-In User Service (RADIUS) is a security authentication client/server protocol that supports authentication, authorization and accounting, which is widely used by Internet service providers. It is the most common method of authenticating and authorizing dial-up and tunneled network users.

The built-in RADIUS client feature enables the router to assist the remote dial-in user or a wireless station and the RADIUS server in performing mutual authentication. It enables centralized remote access authentication for network management.

If you choose WPA-Radius as the security configuration, you have to specify WPA mode, algorithm, Radius server, Radius server port and Radius server secret respectively.

Quick Start Wizard

Wireless System Configuration

Enable Wireless LAN	<input checked="" type="checkbox"/>
SSID Broadcast	Show
SSID	DrayTek
Wireless Security Configuration	
Encryption	WPA-RADIUS
WPA-RADIUS Configuration	
Type	WPA
WPA Algorithm	TKIP
Server IP Address	0.0.0.0
Destination Port	1812
Shared Secret	radius_secret

< Back Next > Finish Cancel

Type

The WPA encrypts each frame transmitted from the radio using the key, which either PSK (Pre-Shared Key) entered manually in this field below or automatically negotiated via 802.1x authentication. Select WPA, WPA2 or Auto as WPA mode.

Auto(WPA or WPA2)
WPA
WPA2
Auto(WPA or WPA2)

WPA Algorithm

Choose the WPA algorithm, TKIP, AES or Auto.

AES
TKIP
AES
Auto(TKIP or AES)

Server IP Address

Enter the IP address of RADIUS server.

Destination Port

The UDP port number that the RADIUS server is using. The default value is 1812, based on RFC 2138.

Shared Secret

The RADIUS server and client share a secret that is used to authenticate the messages sent between them. Both sides must be configured to use the same shared secret.

WPS

WPS (Wi-Fi Protected Setup) provides easy procedure to make network connection between wireless station and wireless access point (vigor router) with the encryption of WPA and WPA2.

If you choose WPS as the security configuration, you can press Start WPS PIN and Start WPS PBC to complete the wireless connection.

Quick Start Wizard

Wireless System Configuration

Enable Wireless LAN	<input checked="" type="checkbox"/>
SSID Broadcast	Show <input type="button" value="v"/>
SSID	DrayTek <input type="text"/>

Wireless Security Configuration

Encryption	WPS <input type="button" value="v"/>
------------	--------------------------------------

WPS Configuration

Configure via Push Button	<input type="button" value="Start PBC"/>
Configure via Client PinCode	<input type="text"/> <input type="button" value="Start PIN"/>

Configure via Push Button Click **Start PBC** to invoke Push-Button style WPS setup procedure. The router will wait for WPS requests from wireless clients about two minutes. The WPS LED on the router will blink fast when WPS is in progress. It will return to normal condition after two minutes. (You need to setup WPS within two minutes)

Configure via Client PinCode Type the PIN code specified in wireless client you wish to connect, and click **Start PIN** button. The WLAN LED on the router will blink fast when WPS is in progress. It will return to normal condition after two minutes. (You need to setup WPS within two minutes)

After finishing the settings here, please click **Next**.

2.4.5 Saving the Wizard Configuration

Now you can see the following screen. It indicates that the setup is complete. Different types of connection modes will have different summary. Click **Finish** and then restart the router.

Quick Start Wizard

Vigor Wizard Setup is now finished!

Press **Finish** button to save and finish the wizard setup.
 You will be prompted for the new password.
 Note that the configuration process takes a few seconds to complete.

2.5 Online Status

The online status shows the system status, WAN status, and other status related to this router within one page. If you select **PPPoE** as the protocol, you will find out a link of **Dial PPPoE** or **Drop PPPoE** in the Online Status web page.

Online Status

Auto-refresh

System Status **System Uptime: 0d 02:42:07**

LAN Status					
IP Address	TX Packets	RX Packets	TX Bytes	RX Bytes	
192.168.1.1	423	652	221973	93684	
IPv6 Address					
2000::1/64 (Global)					
fe80::200:ff:fe00:0/64 (Link)					
WAN Status					
IP	GW IP	Mode	Up Time		
172.16.3.102	172.16.1.1	Static IP	0d 02:41:31		
IPv6 Address					
fe80::250:ff:fe00:2/64 (Link)					
Primary DNS	Secondary DNS	TX Packets	RX Packets	TX Bytes	RX Bytes
168.95.1.1		3195	279336	272182	21928131

Detailed explanation is shown below:

LAN Status

IP Address Displays the IP address of the LAN interface.

TX Packets Displays the total transmitted packets at the LAN interface.

RX Packets	Displays the total received packets at the LAN interface.
TX Bytes	Displays the total transmitted bytes at the LAN interface.
RX Bytes	Displays the total received packets at the LAN interface.
IPv6 Address	Displays the IPv6 address of the LAN interface.
<i>WAN Status</i>	
IP	Displays the IP address of the WAN interface.
GW IP	Displays the IP address of the default gateway.
Mode	Displays the type of WAN connection (e.g., PPPoE).
Up Time	Displays the total uptime of the interface.
IPv6 Address	Displays the IPv6 address of the LAN interface.
Primary DNS	Displays the primary DNS server address for WAN interface.
Secondary DNS	Displays the secondary DNS server address for WAN interface.
TX Packets	Displays the total transmitted packets at the WAN interface.
RX Packets	Displays the total number of received packets at the WAN interface.
TX Bytes	Displays the total transmitted bytes at the WAN interface.
RX Bytes	Displays the total received packets at the WAN interface.

Note: The words in green mean that the WAN connection of that interface is ready for accessing Internet; the words in red mean that the WAN connection of that interface is not ready for accessing Internet.

2.6 Saving Configuration

Each time you click **OK** on the web page for saving the configuration, you can find messages showing the system interaction with you.

Status: Ready

Ready indicates the system is ready for you to input settings.

Settings Saved means your settings are saved once you click **Finish** or **OK** button.

3

User Mode Operation

This chapter will guide users to execute simple configuration through user mode operation.

1. Open a web browser on your PC and type **http://192.168.1.1**. The window will ask for typing username and password.
2. **Do not** type any word (both username and password are Null for user operation) on the window and click **Login** on the window.

Now, the **Main Screen** will appear. Be aware that “User mode” will be displayed on the bottom left side.

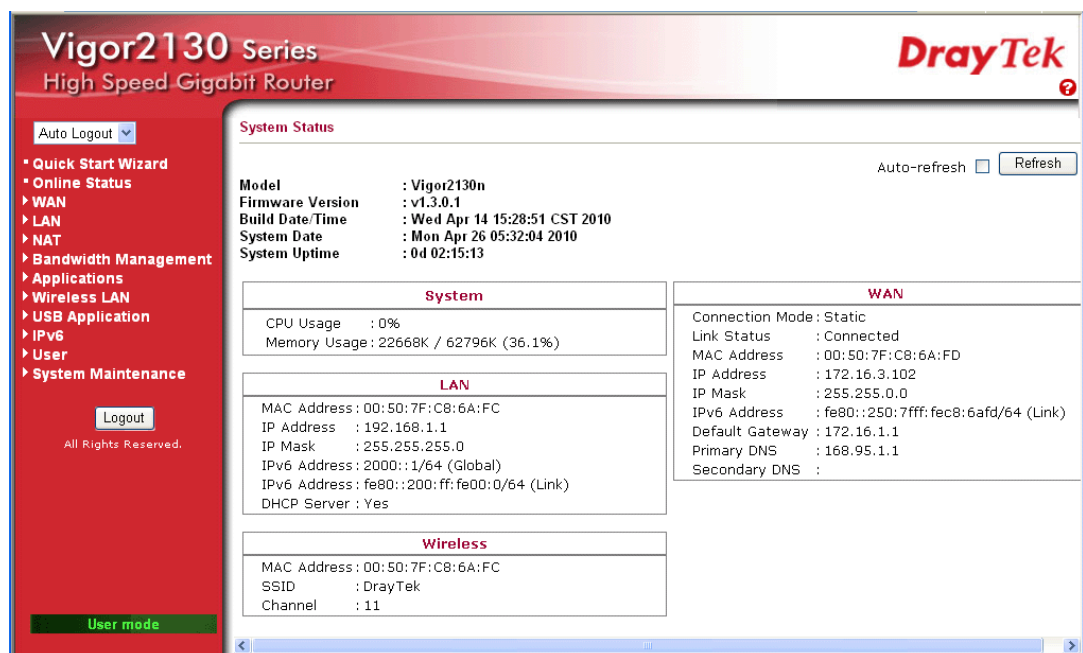

3.1 WAN

Quick Start Wizard offers user an easy method to quick setup the connection mode for the router. Moreover, if you want to adjust more settings for different WAN modes, please go to WAN group.

Basics of Internet Protocol (IP) Network

IP means Internet Protocol. Every device in an IP-based Network including routers, print server, and host PCs, needs an IP address to identify its location on the network. To avoid address conflicts, IP addresses are publicly registered with the Network Information Centre (NIC). Having a unique IP address is mandatory for those devices participated in the public network but not in the private TCP/IP local area networks (LANs), such as host PCs under the management of a router since they do not need to be accessed by the public. Hence, the NIC has reserved certain addresses that will never be registered publicly. These are known as *private* IP addresses, and are listed in the following ranges:

From 10.0.0.0 to 10.255.255.255

From 172.16.0.0 to 172.31.255.255

From 192.168.0.0 to 192.168.255.255

What are Public IP Address and Private IP Address

As the router plays a role to manage and further protect its LAN, it interconnects groups of host PCs. Each of them has a private IP address assigned by the built-in DHCP server of the Vigor router. The router itself will also use the default **private IP** address: 192.168.1.1 to communicate with the local hosts. Meanwhile, Vigor router will communicate with other network devices through a **public IP** address. When the data flow passing through, the Network Address Translation (NAT) function of the router will dedicate to translate public/private addresses, and the packets will be delivered to the correct host PC in the local area network. Thus, all the host PCs can share a common Internet connection.

Get Your Public IP Address from ISP

In ADSL deployment, the PPP (Point to Point)-style authentication and authorization is required for bridging customer premises equipment (CPE). Point to Point Protocol over Ethernet (PPPoE) connects a network of hosts via an access device to a remote access concentrator or aggregation concentrator. This implementation provides users with significant ease of use. Meanwhile it provides access control, billing, and type of service according to user requirement.

When a router begins to connect to your ISP, a serial of discovery process will occur to ask for a connection. Then a session will be created. Your user ID and password is authenticated via **PAP** or **CHAP** with **RADIUS** authentication system. And your IP address, DNS server, and other related information will usually be assigned by your ISP.

Network Connection by 3G USB Modem

For 3G mobile communication through Access Point is popular more and more, Vigor router adds the function of 3G network connection for such purpose. By connecting 3G USB Modem to the USB port of Vigor router, it can support HSDPA/UMTS/EDGE/GPRS/GSM and the future 3G standard (HSUPA, etc). Vigor router with 3G USB Modem allows you to receive 3G signals at any place such as your car or certain location holding outdoor activity and share the bandwidth for using by more people. Users can use four LAN ports on the router to access Internet. Also, they can access Internet via SuperG wireless function of Vigor router, and enjoy the powerful firewall, bandwidth management, VPN, VoIP features of Vigor router.



After connecting into the router, 3G USB Modem will be regarded as the second WAN port. However, the original Ethernet WAN still can be used and Load-Balance can be done in the router. Besides, 3G USB Modem also can be used as backup device. Therefore, when WAN is not available, the router will use 3.5G for supporting automatically. The supported 3G USB Modem will be listed on DrayTek web site. Please visit www.draytek.com for more detailed information.

Below shows the menu items for WAN.

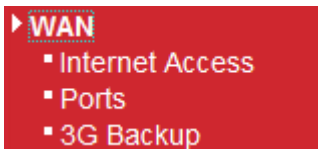

3.1.1 Internet Access

This page allows you to set WAN configuration with different modes. Use the Connection Type drop down list to choose one of the WAN modes. The corresponding page will be displayed.

WAN >> Internet Access

WAN IP Configuration

Connection Type	DHCP	▼
-----------------	------	---

DHCP Settings

Router Name	Vigor2130	(The same as syslog's router name)
-------------	-----------	--------------------------------------

WAN Connection Detection

Mode	ARP	▼
Ping IP	0.0.0.0	

Clone MAC Address

Enable	<input type="checkbox"/>
--------	--------------------------

Static

For static IP mode, you usually receive a fixed public IP address or a public subnet, namely multiple public IP addresses from your DSL or Cable ISP service providers. In most cases, a Cable service provider will offer a fixed public IP, while a DSL service provider will offer a public subnet. If you have a public subnet, you could assign an IP address or many IP address to the WAN interface.

To use **Static** as the accessing protocol of the internet, please choose **Static** mode from **Connection Type** drop down menu. The following web page will be shown.

WAN >> Internet Access

WAN IP Configuration

Connection Type	Static IP
-----------------	-----------

Static IP Settings

IP Address	172.16.3.102
Subnet Mask	255.255.0.0
Gateway IP Address	172.16.1.1
Primary DNS Server	168.95.1.1
Secondary DNS Server	0.0.0.0

WAN Connection Detection

Mode	ARP
Ping IP	0.0.0.0

Clone MAC Address

Enable	<input type="checkbox"/>
--------	--------------------------

OK

- IP Address** Type the IP address.
- Subnet Mask** Type the subnet mask.
- Gateway IP Address** Type the gateway IP address.
- Primary DNS Server** Type in the primary IP address for the router if you want to use **Static IP** mode.
- Secondary DNS Server** Type in secondary IP address for using in the future if necessary.
- Mode** Such function allows you to verify whether network connection is alive or not through ARP Detect or Ping Detect. Choose **ARP Detect** or **Ping Detect** for the system to execute for WAN detection.
- Ping IP** If you choose **Ping Detect** as detection mode, you have to type IP address in this field for ping.
- Clone MAC Address** It is available when the box of Enable is checked. Click **Clone MAC Address**. The result will be displayed in the field of MAC Address.

Enable	<input checked="" type="checkbox"/>	Clone MAC Address
MAC Address		00-0E-A6-2A-D5-A1

After finishing all the settings here, please click **OK** to activate them.

DHCP

DHCP allows a user to obtain an IP address automatically from a DHCP server on the Internet. If you choose **DHCP** mode, the DHCP server of your ISP will assign a dynamic IP address for your router automatically. It is not necessary for you to assign any setting,

WAN >> Internet Access

WAN IP Configuration

Connection Type	DHCP
-----------------	------

DHCP Settings

Router Name	Vigor2130	(The same as syslog's router name)
-------------	-----------	--------------------------------------

WAN Connection Detection

Mode	ARP
Ping IP	0.0.0.0

Clone MAC Address

Enable	<input type="checkbox"/>
--------	--------------------------

OK

Router Name

Type in a name for the router. It must be the same as the name used in Syslog.

Mode

Such function allows you to verify whether network connection is alive or not through ARP Detect or Ping Detect. Choose **ARP Detect** or **Ping Detect** for the system to execute for WAN detection.

Ping IP

If you choose **Ping Detect** as detection mode, you have to type IP address in this field for pinging.

Clone MAC Address

It is available when the box of Enable is checked. Click **Clone MAC Address**. The result will be displayed in the field of MAC Address.

Enable



Clone MAC Address

MAC Address

00-0E-A6-2A-D5-A1

After finishing all the settings here, please click **OK** to activate them.

PPPoE

To choose PPPoE as the accessing protocol of the internet, please select **PPPoE** from the **Internet Access** menu. The following web page will be shown.

WAN >> Internet Access

WAN IP Configuration

Connection Type	PPPoE
-----------------	-------

PPPoE Settings

Username	<input type="text"/>
Password	<input type="password"/>
Redial Policy	Connect on Demand
Idle Time out	<input type="text"/>
MTU Size	<input type="text"/>

WAN Connection Detection

Mode	Ping Detect
Ping IP	0.0.0.0

Clone MAC Address

Enable	<input type="checkbox"/>
--------	--------------------------

OK

- Username** Type in the username provided by ISP in this field.
- Password** Type in the password provided by ISP in this field.
- Redial Policy** If you want to connect to Internet all the time, you can choose **Always On**. Otherwise, choose **Connect on Demand**.
- | |
|-------------------|
| Connect on Demand |
| Connect on Demand |
| Always On |
- Idle Time Out** Set the timeout for breaking down the Internet after passing through the time without any action. When you choose **Connect on Demand**, you have to type value here.
- MTU Size** It means Max Transmit Unit for packet. The default setting is 1442. Leave blank for default value.
- Enable/Disable** Click **Enable** for activating this function. If you click **Disable**, this function will be closed and all the settings that you adjusted in this page will be invalid.
- Mode** Such function allows you to verify whether network connection is alive or not through ARP Detect or Ping Detect. Choose **ARP Detect** or **Ping Detect** for the system to execute for WAN detection.
- Ping IP** If you choose **Ping Detect** as detection mode, you have to type IP address in this field for pinging.
- Clone MAC Address** It is available when the box of Enable is checked. Click **Clone MAC Address**. The result will be displayed in the field of MAC Address.

Enable



Clone MAC Address

MAC Address

00-0E-A6-2A-D5-A1

After finishing all the settings here, please click **OK** to activate them.

PPTP/L2TP

To use **PPTP/L2TP** as the accessing protocol of the internet, please choose **PPTP/L2TP** from **Connection Type** drop down menu. The following web page will be shown.

WAN >> Internet Access

WAN IP Configuration

Connection Type	PPTP
PPTP Settings	
Username	<input type="text"/>
Password	<input type="text"/>
Server Address	0.0.0.0
WAN IP Network Settings	Static IP
IP Address	0.0.0.0
Subnet Mask	0.0.0.0
Primary DNS Server	0.0.0.0
Secondary DNS Server	0.0.0.0
Redial Policy	Connect on Demand
Idle Time out	<input type="text"/>
MTU Size	<input type="text"/>
Clone MAC Address	
Enable	<input type="checkbox"/>

OK Cancel

- Username** Type in the username provided by ISP in this field.
- Password** Type in the password provided by ISP in this field.
- Server Address** Type in the IP address for PPTP /L2TP server.
- WAN IP Network Settings** You can choose Static IP or DHCP as WAN IP network setting.
- IP Address** Type the IP address if you choose Static IP as the WAN IP network setting.
- Subnet Mask** Type the subnet mask if you chose Static IP as the WAN IP.
- Primary DNS Server** If you choose **Static IP** for WAN IP Network Settings, you must specify a DNS server IP address here because your ISP should provide you with usually more than one DNS Server. If your ISP does not provide it, the router will apply a default DNS Server automatically.
- Secondary DNS Server** If you choose **Static IP** for WAN IP Network Settings, you can specify secondary DNS server IP address here because your ISP often provides you more than one DNS Server. If your ISP does not provide it, the router will apply a default secondary DNS Server automatically.

Redial Policy

If you want to connect to Internet all the time, you can choose **Always On**. Otherwise, choose **Connect on Demand** and

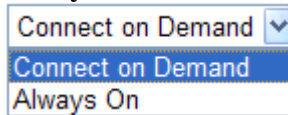

Connect on Demand ▼
Connect on Demand
Always On

Idle Time Out

Set the timeout for breaking down the Internet after passing through the time without any action. When you choose **Connect on Demand**, you have to type value here.

MTU Size

It means Max Transmit Unit for packet. The default setting is 1442.

Clone MAC Address

It is available when the box of Enable is checked. Click **Clone MAC Address**. The result will be displayed in the field of MAC Address.



Enable Clone MAC Address
MAC Address 00-0E-A6-2A-D5-A1

After finishing all the settings here, please click **OK** to activate them.

3G USB Modem

If your router connects to a 3G modem and you want to access Internet via 3G modem, choose 3G as connection type and type the required information in this web page.

WAN >> Internet Access

WAN IP Configuration

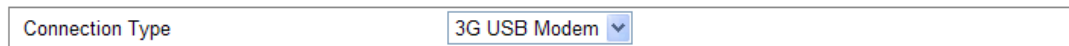

Connection Type 3G USB Modem ▼

3G USB Modem Settings

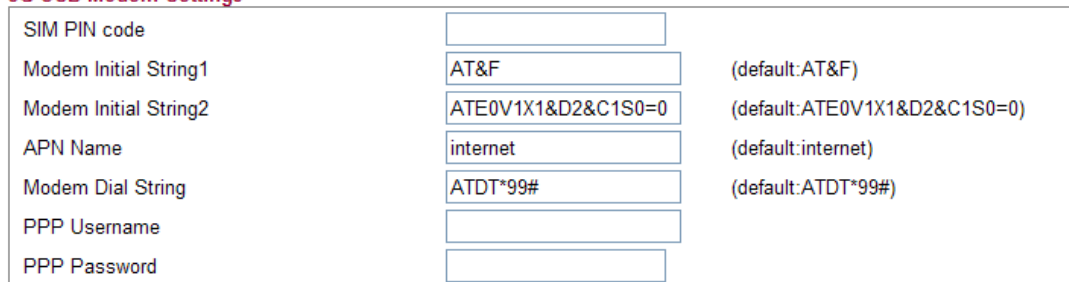

SIM PIN code	<input type="text"/>	
Modem Initial String1	AT&F	(default:AT&F)
Modem Initial String2	ATE0V1X1&D2&C1S0=0	(default:ATE0V1X1&D2&C1S0=0)
APN Name	internet	(default:internet)
Modem Dial String	ATDT*99#	(default:ATDT*99#)
PPP Username	<input type="text"/>	
PPP Password	<input type="text"/>	

Clone MAC Address



Enable



OK Cancel

SIM PIN code

Type PIN code of the SIM card that will be used to access Internet.

Modem Initial String1/2

Such value is used to initialize USB modem. Please use the default value. If you have any question, please contact to your ISP.

APN Name

APN means Access Point Name which is provided and required by some ISPs.

- Modem Dial String** Such value is used to dial through USB mode. Please use the default value. If you have any question, please contact to your ISP.
- PPP Username** Type the PPP username (optional).
- PPP Password** Type the PPP password (optional).
- Clone MAC Address** It is available when the box of Enable is checked. Click **Clone MAC Address**. The result will be displayed in the field of MAC Address.

Enable Clone MAC Address

MAC Address



After finishing all the settings here, please click **OK** to activate them.

3.1.2 Ports

Ports page is used to change the setting for WAN port. You can set or reset the following items. All of them are described in detail below.

WAN >> Ports

Port Configuration

Port	Link	Speed		Flow Control			Maximum Frame	Excessive Collision Mode	Power Control
		Current	Configured	Current Rx	Current Tx	Configured			
WAN		100fdx	Auto			<input type="checkbox"/>	1518	Discard	Enabled

Port It displays current network interface.

Link It displays current connection status. Green light means the WAN connection is successful.

Current It displays current speed that the router uses.

Speed Configured It can set the speed and duplex of the port. You can use the drop down list to choose the required speed for the router. If you have no idea in configuring speed, simple use the default setting, **Auto**.

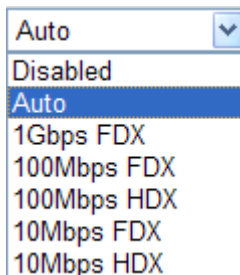

Flow Control If flow control is enabled by checking **Configured** box, both parties can send PAUSE frame to the transmitting device(s) if the receiving port is too busy to handle. If not, there will be no flow control in the port. It drops the packet if too much to handle.

Current Rx: indicates whether pause frames on the port are

obeyed.

Current Tx: indicates whether pause frames on the port are transmitted.

Maximum Frame

This module offers 1518~9600 (Bytes) length to make the long packet for data transmission.

Excessive Collision Mode

There are two modes for you to choose when excessive collision happened in half-duplex condition.

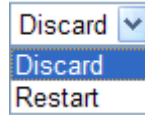

Discard - It determines whether the MAC drops frames after an excessive collision has occurred. If yes, a frame is dropped after excessive collision. This is IEEE Standard 802.3 half-duplex flow control operation.

Restart - It determines whether the MAC retransmits frames after an excessive collision has occurred. If set, a frame is not dropped after excessive collisions, but the backoff sequence is restarted. This is a violation of IEEE Standard 802.3, but is useful in non-dropping half-duplex flow control operation.

Power Control

The Configured column allows for changing the power savings mode parameters per port.

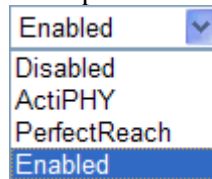

Disabled: All power savings mechanisms disabled.

ActiPHY: Link down power savings enabled.

PerfectReach: Link up power savings enabled.

Enabled: Both link up and link down power savings enabled.

Refresh

Click this button to refresh the information for WAN port.

After finishing all the settings here, please click **OK** to activate them.

3.1.3 3G Backup

This page is used to setup 3G backup function. If you enable 3G backup, make sure your WAN connection type is not in 3G mode. When the WAN connection is broken, router will try to keep the connection with 3G mode. After WAN connection is recovered, router will disconnect the 3G connection automatically.

3G Backup Configuration

<input type="checkbox"/> Enable 3G Backup		
SIM PIN code	<input type="text"/>	
Modem Initial String1	<input type="text" value="AT&F"/>	(default:AT&F)
Modem Initial String2	<input type="text" value="ATE0V1X1&D2&C1S0=0"/>	(default:ATE0V1X1&D2&C1S0=0)
APN Name	<input type="text" value="internet"/>	(default:internet)
Modem Dial String	<input type="text" value="ATDT*99#"/>	(default:ATDT*99#)
PPP Username	<input type="text"/>	
PPP Password	<input type="text"/>	

OK Cancel

- SIM PIN code** Type PIN code of the SIM card that will be used to access Internet.
- Modem Initial String1/2** Such value is used to initialize USB modem. Please use the default value. If you have any question, please contact to your ISP.
- APN Name** APN means Access Point Name which is provided and required by some ISPs.
- Modem Dial String** Such value is used to dial through USB mode. Please use the default value. If you have any question, please contact to your ISP.
- PPP Username** Type the PPP username (optional).
- PPP Password** Type the PPP password (optional).
- Clone MAC Address** It is available when the box of Enable is checked. Click **Clone MAC Address**. The result will be displayed in the field of MAC Address.

Enable	<input checked="" type="checkbox"/>	Clone MAC Address
MAC Address		<input type="text" value="00-0E-A6-2A-D5-A1"/>

3.2 LAN

Local Area Network (LAN) is a group of subnets regulated and ruled by router. The design of network structure is related to what type of public IP addresses coming from your ISP.

Basics of LAN

The most generic function of Vigor router is NAT. It creates a private subnet of your own. As mentioned previously, the router will talk to other public hosts on the Internet by using public IP address and talking to local hosts by using its private IP address. What NAT does is to translate the packets from public IP address to private IP address to forward the right packets to the right host and vice versa. Besides, Vigor router has a built-in DHCP server that assigns private IP address to each local host. See the following diagram for a briefly understanding.

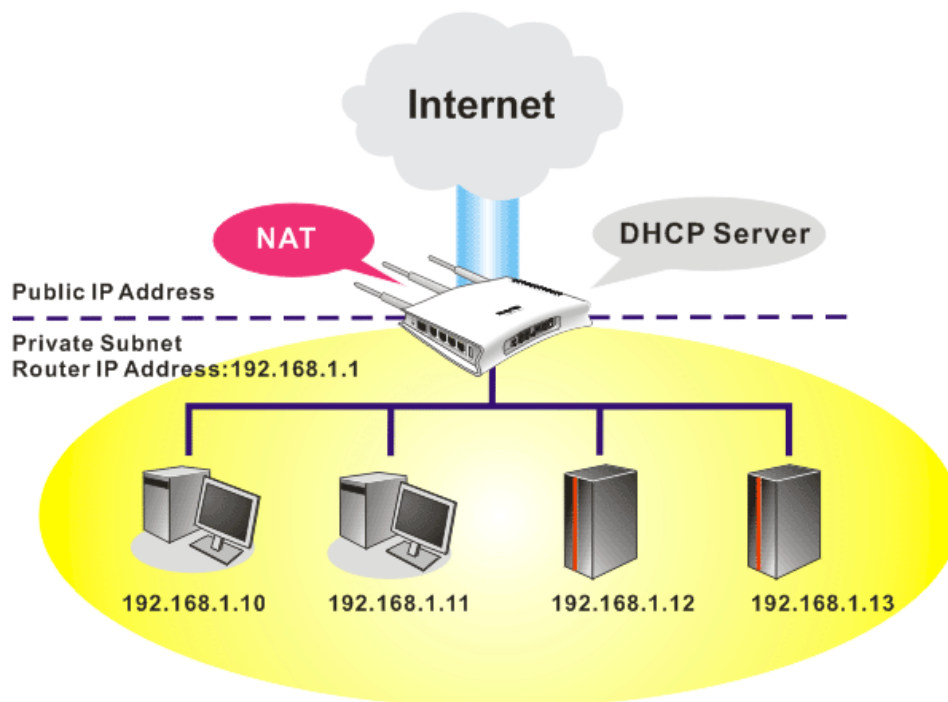

In some special case, you may have a public IP subnet from your ISP such as 220.135.240.0/24. This means that you can set up a public subnet or call second subnet that each host is equipped with a public IP address. As a part of the public subnet, the Vigor router will serve for IP routing to help hosts in the public subnet to communicate with other public hosts or servers outside. Therefore, the router should be set as the gateway for public hosts.

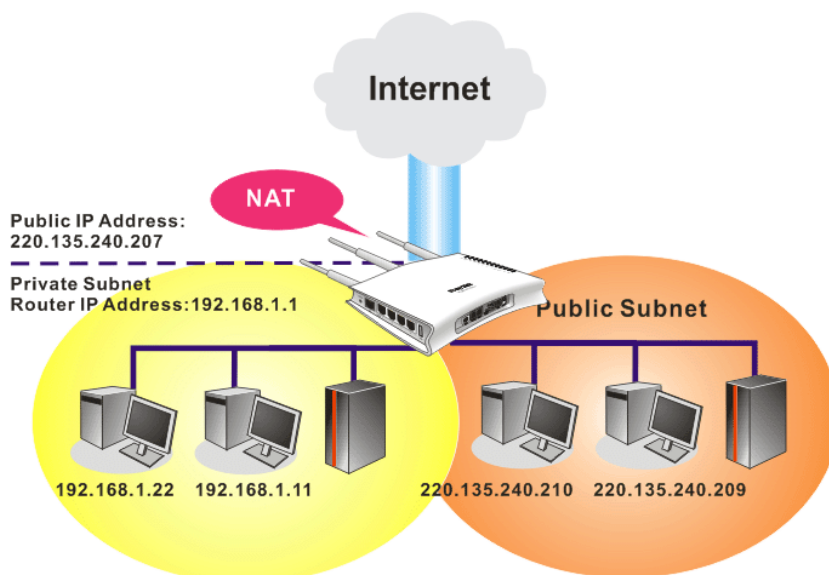

What is Routing Information Protocol (RIP)

Vigor router will exchange routing information with neighboring routers using the RIP to accomplish IP routing. This allows users to change the information of the router such as IP address and the routers will automatically inform for each other.

What are Virtual LANs and Rate Control

You can group local hosts by physical ports and create up to 4 virtual LANs. To manage the communication between different groups, please set up rules in Virtual LAN (VLAN) function and the rate of each.

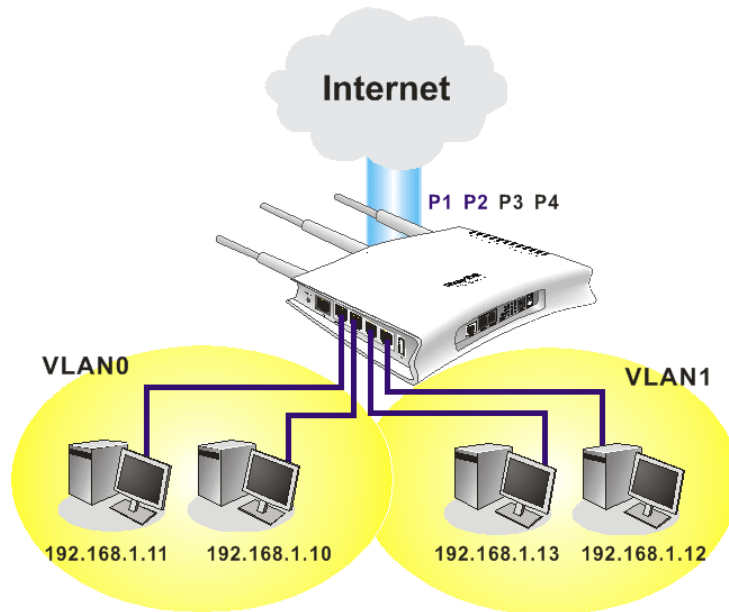

Below shows the LAN menu:

- ▶ LAN
 - General Setup
 - Ports
 - MAC Address Table
 - VLAN
 - Monitor Port
 - Static Route
 - Bind IP to MAC

3.2.1 General Setup

This page provides you the general settings for LAN.

Click **LAN** to open the LAN settings page and choose **General Setup**.

LAN >> General Setup

LAN IP Network Configuration

IP Address	<input type="text" value="192.168.1.1"/>
Subnet Mask	<input type="text" value="255.255.255.0"/>

DHCP Server Configuration

Enable DHCP	<input checked="" type="checkbox"/>
Start IP Address	192.168.1. <input type="text" value="10"/>
IP Pool Counts	<input type="text" value="50"/>
Lease Time	<input type="text" value="720"/> minutes
Force DNS manual setting	<input type="checkbox"/>
Primary IP Address	<input type="text" value="0.0.0.0"/>
Secondary IP Address	<input type="text" value="0.0.0.0"/>

- IP Address** Type in private IP address for connecting to a local private network (Default: 192.168.1.1).
- Subnet Mask** Type in an address code that determines the size of the network. (Default: 255.255.255.0/ 24)
- Enable DHCP** DHCP stands for Dynamic Host Configuration Protocol. The router by factory default acts a DHCP server for your network so it automatically dispatch related IP settings to any local user configured as a DHCP client. It is highly recommended that you leave the router enabled as a DHCP server if you do not have a DHCP server for your network.
You can configure the router to serve as a DHCP server for the 2nd subnet. Check the box to enable DHCP server setting.
- Start IP Address** Enter a value of the IP address pool for the DHCP server to start with when issuing IP addresses. If the 2nd IP address of your router is 220.135.240.1, the starting IP address must be 220.135.240.2 or greater, but smaller than 220.135.240.254.
- IP Pool Counts** Enter the number of IP addresses in the pool. The maximum is 10. For example, if you type 3 and the 2nd IP address of your router is 220.135.240.1, the range of IP address by the DHCP server will be from 220.135.240.2 to 220.135.240.11.
- Lease Time** It allows you to set the leased time for the specified PC.
- Force DNS manual setting** Force router to use DNS servers in this page instead of DNS servers given by the Internet Access server (PPPoE, PPTP, L2TP or DHCP server).
- Primary IP Address** You must specify a DNS server IP address here because your ISP should provide you with usually more than one DNS Server. If your ISP does not provide it, the router will automatically apply default DNS Server IP address: 194.109.6.66 to this field.

Secondary IP Address

You can specify secondary DNS server IP address here because your ISP often provides you more than one DNS Server. If your ISP does not provide it, the router will automatically apply default secondary DNS Server IP address: 194.98.0.1 to this field.

The default DNS Server IP address can be found via Online Status:

If both the Primary IP and Secondary IP Address fields are left empty, the router will assign its own IP address to local users as a DNS proxy server and maintain a DNS cache.

If the IP address of a domain name is already in the DNS cache, the router will resolve the domain name immediately.

Otherwise, the router forwards the DNS query packet to the external DNS server by establishing a WAN (e.g. DSL/Cable) connection.

After finishing all the settings here, please click **OK** to activate them.

















3.2.2 Ports

Ports page is used to change the setting for LAN ports. You can set or reset the following items. All of them are described in detail below.

LAN >> Ports

Port Configuration

Refresh

Port	Link	Speed		Flow Control			Maximum Frame	Excessive Collision Mode	Power Control
		Current	Configured	Current Rx	Current Tx	Configured			
LAN1		Down	Auto				1518	Discard	Enabled
LAN2		1Gfdx	Auto				1518	Discard	Enabled
LAN3		Down	Auto				1518	Discard	Enabled
LAN4		Down	Auto				1518	Discard	Enabled

OK

Cancel

Port

It displays current network interface.

Link

It displays current connection status. Green light means the LAN connection is successful.

Current

It displays current speed that the router uses.

Speed Configured

It can set the speed and duplex of the port. You can use the drop down list to choose the required speed for the router. If you have no idea in configuring speed, simple use the default setting,

Auto.

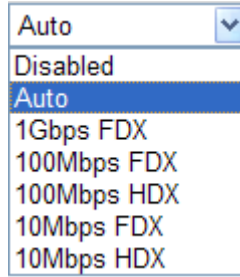

Flow Control

If flow control is enabled by checking **Configured** box, both parties can send PAUSE frame to the transmitting device(s) if the receiving port is too busy to handle. If not, there will be no flow control in the port. It drops the packet if too much to handle.

Current Rx: indicates whether pause frames on the port are obeyed.

Current Tx: indicates whether pause frames on the port are transmitted.

Maximum Frame

This module offers 1518~9600 (Bytes) length to make the long packet for data transmission.

Excessive Collision Mode

There are two modes for you to choose when excessive collision happened in half-duplex condition.

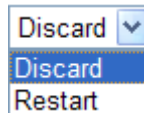

Discard - It determines whether the MAC drops frames after an excessive collision has occurred. If yes, a frame is dropped after excessive collision. This is IEEE Standard 802.3 half-duplex flow control operation.

Restart - It determines whether the MAC retransmits frames after an excessive collision has occurred. If set, a frame is not dropped after excessive collisions, but the backoff sequence is restarted. This is a violation of IEEE Standard 802.3, but is useful in non-dropping half-duplex flow control operation.

Power Control

The Configured column allows for changing the power savings mode parameters per port.

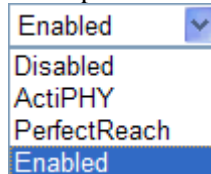

Disabled: All power savings mechanisms disabled.

ActiPHY: Link down power savings enabled.

PerfectReach: Link up power savings enabled.

Enabled: Both link up and link down power savings enabled.

Refresh

Click this button to refresh the information for LAN ports.

After finishing all the settings here, please click **OK** to activate them.

3.2.3 MAC Address Table

This page allows you to set timeouts for entries in dynamic MAC Table and configure the static MAC table here.

LAN >> MAC Address Table

MAC Address Table Configuration

Aging Configuration

Disable Automatic Aging	<input type="checkbox"/>
Age Time	<input type="text" value="300"/> seconds

MAC Table Learning

	WAN	LAN1	Port Members LAN2	LAN3	LAN4
Auto	<input checked="" type="radio"/>	<input checked="" type="radio"/>	<input checked="" type="radio"/>	<input checked="" type="radio"/>	<input checked="" type="radio"/>
Disable	<input type="radio"/>	<input type="radio"/>	<input type="radio"/>	<input type="radio"/>	<input type="radio"/>
Secure	<input type="radio"/>	<input type="radio"/>	<input type="radio"/>	<input type="radio"/>	<input type="radio"/>

Static MAC Table Configuration

Delete	VLAN ID	MAC Address	Port Members WAN	LAN1	LAN2	LAN3	LAN4
<input type="button" value="Add New Static Entry"/>							

Disable Automatic Aging

Stop the MAC table aging timer, the learned MAC address will not age out automatically. The default setting is enabled. Check the box to disable this function if required.

Age Time

Delete a MAC address idling for a period of time from the following MAC Table, which will not affect static MAC address. Range of MAC Address Aging Time is 10-1000000 seconds. The default Aging Time is 300 seconds.

MAC Table Learning

List the port members which apply dynamic learning mechanism or not.

Auto - Enable this port MAC address dynamic learning mechanism.

Disable - Disable this port MAC address dynamic learning mechanism, only support static MAC address setting.

Secure - Disable this port MAC address dynamic learning mechanism and copy the dynamic learning packets to CPU.

Static MAC Table Config..

Specify static MAC address with VLAN ID to apply aging configuration.

Delete - Click the button to remove the VLAN setting.

VLAN ID - Specify the interface for the port members.

MAC Address - It is a six-byte long Ethernet hardware address and usually expressed by hex and separated by hyphens. For example, 00 - 40 - C7 - D6 - 00 - 02.

WAN/LAN1~4 - Check the port to apply this VLAN setting.

To add a new static MAC entry, click **Add new static entry**. A new entry will be shown as follows. Choose VLAN ID and type a new MAC address. Next, specify port member for this table. Finally, click OK to save the changes.

Static MAC Table Configuration

Delete	VLAN ID	MAC Address	WAN	Port Members			
				LAN1	LAN2	LAN3	LAN4
<input type="button" value="Delete"/>	1(LAN) ▾	00-00-00-00-00-00	<input type="checkbox"/>	<input type="checkbox"/>	<input type="checkbox"/>	<input type="checkbox"/>	<input type="checkbox"/>

3.2.4 VLAN

Virtual LAN function provides you a very convenient way to manage hosts by grouping them based on the physical port. You can also manage the in/out rate of each port. Go to **LAN** page and select **VLAN**. The following page will appear. VLAN function is enabled in default.

LAN >> VLAN

Private VLAN Membership Configuration

Delete	PVLAN ID	LAN1	Port Members			
			LAN2	LAN3	LAN4	
<input type="checkbox"/>	1	<input checked="" type="checkbox"/>	<input checked="" type="checkbox"/>	<input checked="" type="checkbox"/>	<input checked="" type="checkbox"/>	<input checked="" type="checkbox"/>

Add New Private VLAN

Click this button to add a new private VLAN. The router allows you to add up to 4 VLAN.

LAN >> VLAN

Private VLAN Membership Configuration

Delete	PVLAN ID	LAN1	Port Members			
			LAN2	LAN3	LAN4	
<input type="checkbox"/>	1	<input checked="" type="checkbox"/>	<input checked="" type="checkbox"/>	<input checked="" type="checkbox"/>	<input checked="" type="checkbox"/>	<input checked="" type="checkbox"/>
<input type="button" value="Delete"/>	<input type="text" value="0"/>	<input type="checkbox"/>	<input type="checkbox"/>	<input type="checkbox"/>	<input type="checkbox"/>	<input type="checkbox"/>
<input type="button" value="Delete"/>	<input type="text" value="0"/>	<input type="checkbox"/>	<input type="checkbox"/>	<input type="checkbox"/>	<input type="checkbox"/>	<input type="checkbox"/>
<input type="button" value="Delete"/>	<input type="text" value="0"/>	<input type="checkbox"/>	<input type="checkbox"/>	<input type="checkbox"/>	<input type="checkbox"/>	<input type="checkbox"/>

To add or remove a VLAN, please refer to the following example.

1. VLAN 1 is consisted of hosts linked to P1 ~ P4.
2. After checking the box to enable VLAN function, you will check the table according to the needs as shown below.

LAN >> VLAN

Private VLAN Membership Configuration

Delete	PVLAN ID	Port Members			
		LAN1	LAN2	LAN3	LAN4
<input type="checkbox"/>	1	<input checked="" type="checkbox"/>	<input checked="" type="checkbox"/>	<input checked="" type="checkbox"/>	<input checked="" type="checkbox"/>
Delete	<input type="text" value="0"/>	<input type="checkbox"/>	<input type="checkbox"/>	<input type="checkbox"/>	<input type="checkbox"/>
Delete	<input type="text" value="0"/>	<input type="checkbox"/>	<input type="checkbox"/>	<input type="checkbox"/>	<input type="checkbox"/>
Delete	<input type="text" value="0"/>	<input type="checkbox"/>	<input type="checkbox"/>	<input type="checkbox"/>	<input type="checkbox"/>

Add New Private VLAN

OK Cancel

3. To remove VLAN, click the **Delete** button for the one you want to remove and click **OK** to save the results.

3.2.5 Monitor Port

It is used to monitor the traffic of the network. For example, we assume that LAN1 and LAN2 are Monitor Port and Monitor ingress Port respectively, thus, the traffic received by LAN2 will be copied to LAN1 for monitoring.

LAN >> Monitor Port

Monitor Port

Enable Monitor Port

	LAN 1	LAN 2	LAN 3	LAN 4
Monitor Port	<input checked="" type="radio"/>	<input type="radio"/>	<input type="radio"/>	<input type="radio"/>
Monitor ingress port	<input type="checkbox"/>	<input type="checkbox"/>	<input type="checkbox"/>	<input type="checkbox"/>
Monitor egress port	<input type="checkbox"/>	<input type="checkbox"/>	<input type="checkbox"/>	<input type="checkbox"/>

OK

Enable Monitor Port

Check to enable this function.

Monitor Port

Click the one of the LAN ports to specify it for monitoring.

Monitor ingress port

Check to set up the port(s) for being monitored. It only monitors the packets **received** by the port you set up.

Monitor egress port

Check to set up the port(s) for being monitored. It only monitors the packets **transmitted** by the port you set up.

3.2.6 Static Route

Go to **LAN** and choose **Static Route** to open setting page.

LAN >> Static Route

Static Route Configuration

Index	Destination Address	Status
<input type="button" value="Add"/>		

Index	The number (1 to 10) under Index displays current static router.
Destination Address	Display the destination address of the static route.
Status	Display the status of the static route.
Add	Add a new static route.

Add Static Routes to Private and Public Networks

Here is an example of setting Static Route in Main Router so that user A and B locating in different subnet can talk to each other via the router. Assuming the Internet access has been configured and the router works properly:

- use the Main Router to surf the Internet.
- create a private subnet 192.168.10.0 using an internal Router A (192.168.1.2)
- create a public subnet 211.100.88.0 via an internal Router B (192.168.1.3).
- have set Main Router 192.168.1.1 as the default gateway for the Router A 192.168.1.2.

Before setting Static Route, user A cannot talk to user B for Router A can only forward recognized packets to its default gateway Main Router.

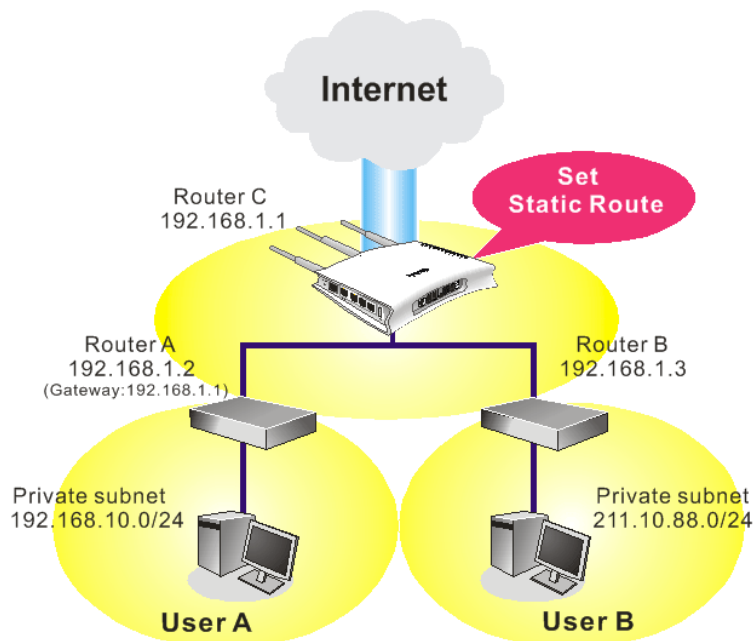

1. Click the **LAN - Static Route** and click **Add**. Check the **Enable** box. Please add a static route as shown below, which regulates all packets destined to 192.168.10.0 will be forwarded to 192.168.1.2. Click **OK**.

LAN >> Static Route

Add Static Route

<input checked="" type="checkbox"/> Enable	
Destination IP Address	192.168.10.0
Subnet Mask	255.255.255.0
Gateway IP Address	192.168.1.2

OK Cancel

2. Return to **Static Route** page. Click **Add** again to add another static route as show below, which regulates all packets destined to 211.100.88.0 will be forwarded to 192.168.1.3.

LAN >> Static Route

Add Static Route

<input checked="" type="checkbox"/> Enable	
Destination IP Address	211.100.88.0
Subnet Mask	255.255.255.0
Gateway IP Address	192.168.1.3

OK Cancel

3. Verify current routing table.

LAN >> Static Route

Static Route Configuration

Index	Destination Address	Status
1	192.168.10.0/255.255.255.0	✓
2	211.100.88.0/255.255.255.0	✓

Add

3.2.7 Bind IP to MAC

This function is used to bind the IP and MAC address in LAN to have a strengthening control in network. When this function is enabled, all the assigned IP and MAC address binding together cannot be changed. If you modified the binding IP or MAC address, it might cause you not access into the Internet.

Click **LAN** and click **Bind IP to MAC** to open the setup page.

Bind IP to MAC

Note: IP-MAC binding presets DHCP Allocations.
If you select Strict Bind, unspecified LAN clients cannot access the Internet.

Enable
 Disable
 Strict Bind

ARP Table | [Select All](#) | [Sort](#) | [Refresh](#) | **IP Bind List** | [Select All](#) | [Sort](#)

IP Address	Mac Address
192.168.1.10	00:0E:A6:2A:D5:A1

Index	IP Address	Mac Address
-------	------------	-------------

Add and Edit

IP Address

Mac Address : : : : :

Enable

Click this radio button to invoke this function. However, IP/MAC which is not listed in IP Bind List also can connect to Internet.

Disable

Click this radio button to disable this function. All the settings on this page will be invalid.

Strict Bind

Click this radio button to block the connection of the IP/MAC which is not listed in IP Bind List.

ARP Table

This table is the LAN ARP table of this router. The information for IP and MAC will be displayed in this field. Each pair of IP and MAC address listed in ARP table can be selected and added to IP Bind List by clicking **Add** below.

Add and Edit

IP Address – Type the IP address that will be used for the specified MAC address.

Mac Address – Type the MAC address that is used to bind with the assigned IP address.

Refresh

It is used to refresh the ARP table. When there is one new PC added to the LAN, you can click this link to obtain the newly ARP table information.

IP Bind List

It displays a list for the IP bind to MAC information.

Add

It allows you to add the one you choose from the ARP table or the IP/MAC address typed in **Add and Edit** to the table of **IP Bind List**.

Edit

It allows you to edit and modify the selected IP address and MAC address that you create before.

Remove

You can remove any item listed in **IP Bind List**. Simply click and select the one, and click **Remove**. The selected item will be removed from the **IP Bind List**.

Note: Before you select **Strict Bind**, you have to bind one set of IP/MAC address for one PC. If not, no one of the PCs can access into Internet. And the web configurator of the router might not be accessed.

3.3 NAT

Usually, the router serves as an NAT (Network Address Translation) router. NAT is a mechanism that one or more private IP addresses can be mapped into a single public one. Public IP address is usually assigned by your ISP, for which you may get charged. Private IP addresses are recognized only among internal hosts.

When the outgoing packets destined to some public server on the Internet reach the NAT router, the router will change its source address into the public IP address of the router, select the available public port, and then forward it. At the same time, the router shall list an entry in a table to memorize this address/port-mapping relationship. When the public server response, the incoming traffic, of course, is destined to the router's public IP address and the router will do the inversion based on its table. Therefore, the internal host can communicate with external host smoothly.

The benefit of the NAT includes:

- **Save cost on applying public IP address and apply efficient usage of IP address.** NAT allows the internal IP addresses of local hosts to be translated into one public IP address, thus you can have only one IP address on behalf of the entire internal hosts.
- **Enhance security of the internal network by obscuring the IP address.** There are many attacks aiming victims based on the IP address. Since the attacker cannot be aware of any private IP addresses, the NAT function can protect the internal network.

On NAT page, you will see the private IP address defined in RFC-1918. Usually we use the 192.168.1.0/24 subnet for the router. As stated before, the NAT facility can map one or more IP addresses and/or service ports into different specified services. In other words, the NAT function can be achieved by using port mapping methods.

Below shows the menu items for NAT.

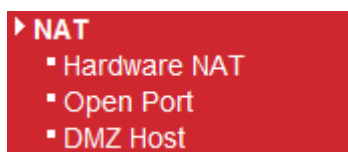

3.3.1 Hardware NAT

Hardware-base Acceleration Engine, also named Protocol Processing Engine API is the function that Draytek provides to extremely speed up the NAT performance.

While the hardware acceleration mechanism is activated, most of the bandwidth usage will be concentrated on the specific sessions which increase transmission speed to get ultimately accelerated.

With Hardware NAT, LAN to WAN NAT throughput can be over 900M bps. But be sure that your PC has Giga Ethernet and connect with CAT6 Ethernet cable.

NAT >> Hardware NAT

Hardware NAT Configuration

Hardware NAT	Enabled ▾
--------------	-----------

OK Cancel

3.3.2 Open Ports

Open Ports allows you to open a range of ports for the traffic of special applications.

NAT >> Open Port

Port Forwarding

Name	Protocol	Start Port	End Port	Local Host	Local Port
No Port Forwarding					

Add New Entry

Common application of Open Ports includes P2P application (e.g., BT, KaZaA, Gnutella, WinMX, eMule and others), Internet Camera etc. Ensure that you keep the application involved up-to-date to avoid falling victim to any security exploits.

To add a new open port, click **Add new entry**.

NAT >> Open Port

Add Port Forwarding Entry

Name	<input type="text"/>
Protocol	TCP+UDP ▾
Start Port	<input type="text"/>
End Port (optional)	<input type="text"/>
Local Host	<input type="text"/>
Local Port (optional)	<input type="text"/>

OK Cancel

Name

Specify the name for the defined network service.

Protocol

Specify the transport layer protocol. It could be **TCP**, **UDP** and **TCP+UDP**.

TCP+UDP ▾
TCP+UDP
TCP
UDP

Start Port

Specify the starting port number of the service offered by the local host.

End Port (optional)

Specify the ending port number of the service offered by the local host.

Local Host

Enter the private IP address of the local host.

Local Port (optional)

If it is configured, the forwarded traffic is mapped to this port on the local host.

3.3.3 DMZ Host

Vigor router provides a facility **DMZ Host** that maps ALL unsolicited data on any protocol to a single host in the LAN. Regular web surfing and other such Internet activities from other clients will continue to work without inappropriate interruption. **DMZ Host** allows a defined internal user to be totally exposed to the Internet, which usually helps some special applications such as Netmeeting or Internet Games etc.

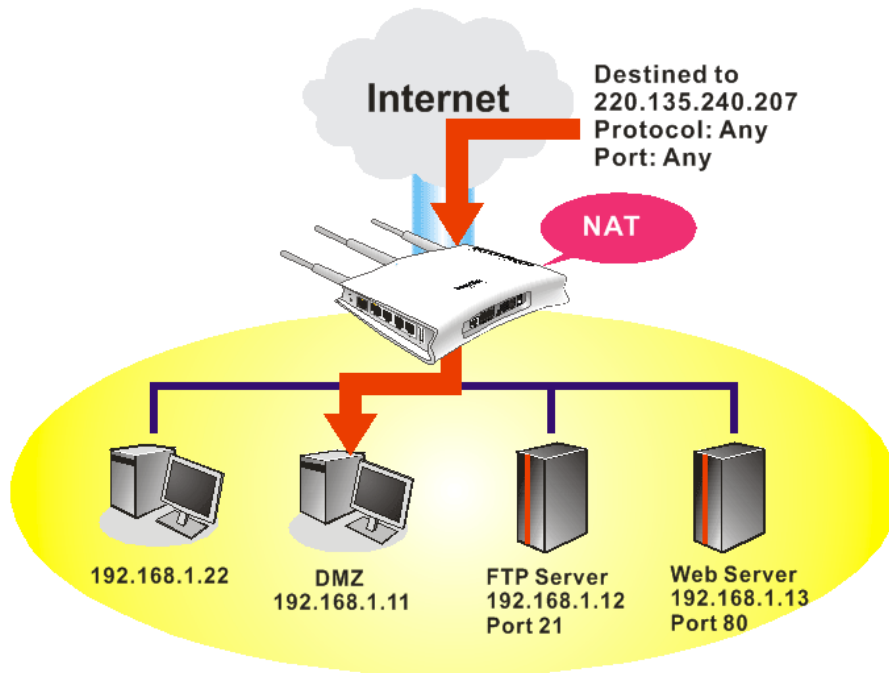

Note: The security properties of NAT are somewhat bypassed if you set up DMZ host. We suggest you to add additional filter rules or a secondary firewall.

Click **DMZ Host** to open the following page:

NAT >> DMZ Host

DMZ Host

Enable <input checked="" type="checkbox"/>	DMZ IP 0.0.0.0	Choose PC
OK		Cancel

Enable

Check to enable the DMZ Host function.

DMZ IP

Enter the private IP address of the DMZ host, or click **Choose PC** to select one.

3.4 Bandwidth Management

Below shows the menu items for Bandwidth Management.



3.4.1 Session Limit

A PC with private IP address can access to the Internet via NAT router. The router will generate the records of NAT sessions for such connection. The P2P (Peer to Peer) applications (e.g., BitTorrent) always need many sessions for procession and also they will occupy over resources which might result in important accesses impacted. To solve the problem, you can use limit session to limit the session procession for specified Hosts.

In the **Bandwidth Management** menu, click **Sessions Limit** to open the web page.

Bandwidth Management >> Session Limit

Session Limit Configuration

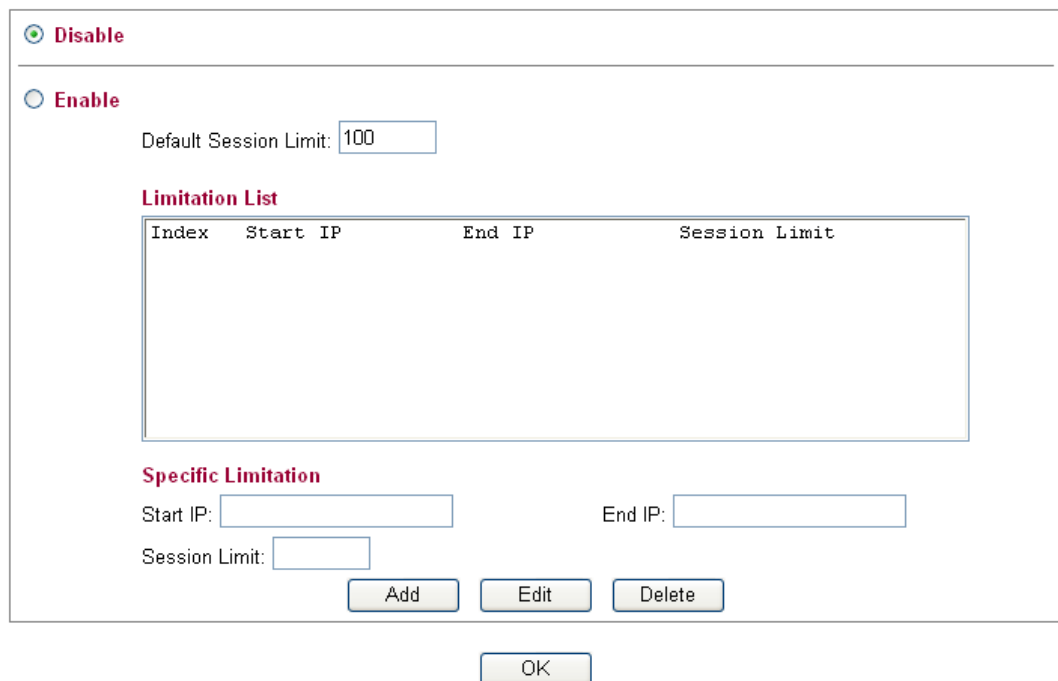

The configuration page for Session Limit. At the top, there are two radio buttons: 'Disable' (selected) and 'Enable'. Below this is a text input field for 'Default Session Limit' with the value '100'. A section titled 'Limitation List' contains an empty table with columns 'Index', 'Start IP', 'End IP', and 'Session Limit'. Below the table is a 'Specific Limitation' section with input fields for 'Start IP', 'End IP', and 'Session Limit'. At the bottom of this section are three buttons: 'Add', 'Edit', and 'Delete'. At the very bottom of the page is an 'OK' button.

To activate the function of limit session, simply click **Enable** and set the default session limit.

Disable

Click this button to close the function of limit session.

Enable

Click this button to activate the function of limit session.

Default Session Limit

Defines the default session number used for each computer in LAN.

Limitation List

Displays a list of specific limitations that you set on this web page.

- Start IP** Defines the start LAN IP address for limit session.
- End IP** Defines the end LAN IP address for limit session.
- Sessions Limit** Defines the available session number for each host in the specific range of IP addresses. If you do not set the session number in this field, the system will use the default session limit for the specific limitation you set for each index.
- Add** Adds the specific session limitation onto the list above.
- Edit** Allows you to edit the settings for the selected limitation.
- Delete** Remove the selected settings existing on the limitation list.

When you finish adding a new session limit, simply click **OK**.

3.4.2 Bandwidth Limit

The downstream or upstream from FTP, HTTP or some P2P applications will occupy large of bandwidth and affect the applications for other programs. Please use Limit Bandwidth to make the bandwidth usage more efficient.

In the **Bandwidth Management** menu, click **Bandwidth Limit** to open the web page.

Bandwidth Management >> Bandwidth Limit

Bandwidth Limit Configuration

Disable

Enable

Smart Bandwidth Limit
 When session number exceeds
 TX Limit: Kbps RX Limit: Kbps

User-defined Bandwidth Limit

Limitation List

Index	Start IP	End IP	TX limit	RX limit

Specific Limitation

Start IP: End IP:

TX Limit: Kbps RX Limit: Kbps

1. Bandwidth limit only works for 'NEW' sessions. Original sessions are controlled by HNAT.
2. If the IP is controlled by bandwidth limit, throughput would be lower than 85Mbps.

To activate the function of limit bandwidth, simply click **Enable** and set the default or user-defined upstream and downstream limit.

- Disable** Click this button to close the function of limit bandwidth.
- Enable** Click this button to activate the function of limit bandwidth.

Smart Bandwidth Limit

Click this radio button to configure the default limitation for bandwidth.

When session number exceeds – type the value here as a threshold to apply the smart bandwidth limit.

TX limit - Define the default speed of the upstream for each computer in LAN.

RX limit - Define the default speed of the downstream for each computer in LAN.

User-defined Bandwidth Limit

Click this radio button to configure the user-defined limitation for bandwidth.

Limitation List - Display a list of specific limitations that you set on this web page.

Start IP - Bandwidth limit can be applied on certain IP range. That's, only the PCs within the range will be influenced by the bandwidth limitation set here. Please define the start IP address for the specific limitation.

End IP - Define the end IP address for the specific limitation.

TX Limit - Define the limitation for the speed of the upstream to be applied as specific limitation. If you do not set the limit in this field, the system will use the default speed for the specific limitation you set for each index.

RX Limit - Define the limitation for the speed of the downstream to be applied as specific limitation. If you do not set the limit in this field, the system will use the default speed for the specific limitation you set for each index.

Add - Add the specific speed limitation onto the list above.

Edit - Allows you to edit the settings for the selected limitation.

Delete - Remove the selected settings existing on the limitation list.

When you finish adding a new bandwidth limit, simply click **OK**.

3.4.3 Port Rate Control

A policer can limit the bandwidth of received frames. It is located in front of the ingress queue. And a shaper can limit the bandwidth of transmitted frames. It is located after the ingress queues. This page allows you to configure the switch port rate limit for Policers and Shapers.

Bandwidth Management >> Port Rate Control

Rate Limit Configuration

Port	Policer Enabled	Policer Rate(Rx)	Policer Unit	Shaper Enabled	Shaper Rate(Tx)	Shaper Unit
WAN	<input type="checkbox"/>	500	kbps	<input checked="" type="checkbox"/>	10	Mbps

Note: Shaper must be enabled for Weighted Queuing Mode QoS!!

OK Cancel

Port	Represent LAN or WAN interface.
Policer Enabled	Check this box to enable policer function.
Policer Rate(Rx)	Type the number for policer function. The default value is 500. It is restricted to 500-1000000 when the Policer Unit is set in kbps, and it is restricted to 1-1000 when the Policer Unit is set in Mbps.
Policer Unit	Determine the unit (kbps/Mbps) for policer.
Shaper Enabled	Check this box to enable shaper function.
Shaper Rate (Tx)	Type the number for shaper function. The default value is 500. It is restricted to 500-1000000 when the Shaper Unit is set in kbps, and it is restricted to 1-1000 when the Shaper Unit is set in Mbps.
Shaper Unit	Determine the unit (kbps/Mbps) for shaper function.

3.4.4 QoS Control List

Deploying QoS (Quality of Service) management to guarantee that all applications receive the service levels required and sufficient bandwidth to meet performance expectations is indeed one important aspect of modern enterprise network.

One reason for QoS is that numerous TCP-based applications tend to continually increase their transmission rate and consume all available bandwidth, which is called TCP slow start. If other applications are not protected by QoS, it will detract much from their performance in the overcrowded network. This is especially essential to those are low tolerant of loss, delay or jitter (delay variation).

Another reason is due to congestions at network intersections where speeds of interconnected circuits mismatch or traffic aggregates, packets will queue up and traffic can be throttled back to a lower speed. If there's no defined priority to specify which packets should be discarded (or in another term "dropped") from an overflowing queue, packets of sensitive applications mentioned above might be the ones to drop off. How this will affect application performance?

There are two components within Primary configuration of QoS deployment:

- Classification: Identifying low-latency or crucial applications and marking them for high-priority service level enforcement throughout the network.

- **Scheduling:** Based on classification of service level to assign packets to queues and associated service types

The basic QoS implementation in Vigor routers is to classify and schedule packets based on the service type information in the IP header. For instance, to ensure the connection with the headquarter, a teleworker may enforce an index of QoS Control to reserve bandwidth for HTTPS connection while using lots of application at the same time.

One more larger-scale implementation of QoS network is to apply DSCP (Differentiated Service Code Point) and IP Precedence disciplines at Layer 3. Compared with legacy IP Precedence that uses Type of Service (ToS) field in the IP header to define 8 service classes, DSCP is a successor creating 64 classes possible with backward IP Precedence compatibility. In a QoS-enabled network, or Differentiated Service (DiffServ or DS) framework, a DS domain owner should sign a Service License Agreement (SLA) with other DS domain owners to define the service level provided toward traffic from different domains. Then each DS node in these domains will perform the priority treatment. This is called per-hop-behavior (PHB). The definition of PHB includes Expedited Forwarding (EF), Assured Forwarding (AF), and Best Effort (BE). AF defines the four classes of delivery (or forwarding) classes and three levels of drop precedence in each class.

Vigor routers as edge routers of DS domain shall check the marked DSCP value in the IP header of bypassing traffic, thus to allocate certain amount of resource execute appropriate policing, classification or scheduling. The core routers in the backbone will do the same checking before executing treatments in order to ensure service-level consistency throughout the whole QoS-enabled network.

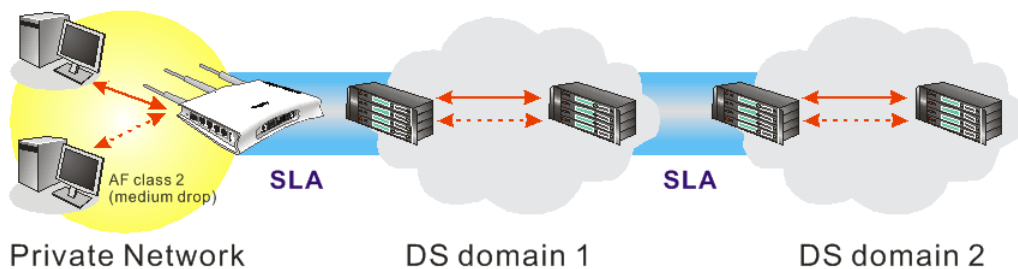

However, each node may take different attitude toward packets with high priority marking since it may bind with the business deal of SLA among different DS domain owners. It's not easy to achieve deterministic and consistent high-priority QoS traffic throughout the whole network with merely Vigor router's effort.

In the **Bandwidth Management** menu, click **QoS Control List (QCL)** to open the web page.

Bandwidth Management >> QoS Control List

QoS Control List Configuration

QCL # 1 ▾

QCE Type	Type Value	Traffic Class	
TCP/UDP Port	22 - 23	High	
TCP/UDP Port	5060	High	
TCP/UDP Port	25	Medium	
TCP/UDP Port	80	Medium	
TCP/UDP Port	110	Medium	
TCP/UDP Port	443	Medium	
DSCP	0	Low	

Note: A QCL consists of an ordered list of up to 12 QCEs.

QCE Type Display the type of that QCE (QoS Control Entries).

Type Value Display the value specified for the QCE.

Traffic Class Display the class of the data transmission for the QCE.

QoS Control List allows users to set up to **five** groups of QCL. Each QCL group can contain 12 QCE settings.

QoS Control List Configuration

QCL # 1 ▾

1
2
3
4
5

QCE Type	Type Value
TCP/UDP Port	22 - 23

Adding a New QCE

Click to add a new QCE onto this page. Different QCE type will bring out different web settings.

- If you choose **Ethernet Type** as QCE Type, you have to type value for it and specify traffic class from Low, Normal, Medium and High.

Bandwidth Management >> QoS Control List

QCE Configuration

QCE Type	Ethernet Type
Ethernet Type Value	0xFFFF
Traffic Class	Low

Low
Normal
Medium
High

OK Cancel

Ethernet Type Value Either **8~63** ASCII characters, such as 012345678(or 64 Hexadecimal digits leading by 0x, such as "0x321253abcde...").

- If you choose **VLAN ID** as QCE Type, you have to type the ID number for it and specify traffic class from Low, Normal, Medium and High.

Bandwidth Management >> QoS Control List

QCE Configuration

QCE Type	VLAN ID
VLAN ID	1
Traffic Class	Low

Low
Normal
Medium
High

OK Cancel

- If you choose **TCP/UDP Port** as QCE Type, you have to type the port number for it and specify traffic class from Low, Normal, Medium and High.

Bandwidth Management >> QoS Control List

QCE Configuration

QCE Type	TCP/UDP Port
TCP/UDP Port	Range
TCP/UDP Port Range	0 65535
Traffic Class	Low

Low
Normal
Medium
High

OK Cancel

TCP/UDP Port Click **Single** or **Range**. If you select **Range**, you have to type in the starting port number and the end porting number on the boxes below.

TCP/UDP Port Range Type in the starting port number and the end porting number here if you choose **Range** as the type.

- If you choose **DSCP** as QCE Type, you have to type value for it and specify traffic class from Low, Normal, Medium and High.

Bandwidth Management >> QoS Control List

QCE Configuration

QCE Type	DSCP
DSCP Value	63
Traffic Class	Low

Low
Normal
Medium
High

OK Cancel

- If you choose **ToS** as QCE Type, you have to specify priority class from Low, Normal, Medium and High.

Bandwidth Management >> QoS Control List

QCE Configuration

QCE Type	ToS
ToS Priority 0 Class	Low
ToS Priority 1 Class	Low
ToS Priority 2 Class	Low
ToS Priority 3 Class	Low
ToS Priority 4 Class	Low
ToS Priority 5 Class	Low
ToS Priority 6 Class	Low
ToS Priority 7 Class	Low

Low
Normal
Medium
High

OK Cancel

- If you choose **Tag Priority** as QCE Type, you have to specify priority class from Low, Normal, Medium and High.

Bandwidth Management >> QoS Control List

QCE Configuration

QCE Type	Tag Priority
Tag Priority 0 Class	Normal
Tag Priority 1 Class	Low
Tag Priority 2 Class	Low
Tag Priority 3 Class	Normal
Tag Priority 4 Class	Medium
Tag Priority 5 Class	Medium
Tag Priority 6 Class	High
Tag Priority 7 Class	High



Low
Normal
Medium
High

OK Cancel

Editing a QCE

Click  to modify the settings of an existing QCE on this page.

Moving Up/Down a QCE

Click  and  to move a QCE up and down.

Deleting a QCE

To delete a QCE in the list, simply click  of that one. It will be removed immediately.

3.4.5 Ports Priority

This page allows you to configure QoS settings for each port. The classification is controlled by a QCL (Quality Control List) that is assigned to each port. A QCL consists of an ordered list of up to 12 QCEs (Quality Control Entry). Each QCE can be used to classify certain frames to a specific QoS class. This classification can be based on parameters such as VLAN ID, UDP/TCP port, IPv4/IPv6 DSCP or Tag Priority. Frames not matching any of the QCEs are classified to the default QoS class for the port.

Bandwidth Management >> Ports Priority

Port QoS Configuration

Port	Default Class	QCL #	Queuing Mode	Queuing Weighted			
				Low	Normal	Medium	High
WAN	Normal	1	Weighted	1	2	4	8

Port Indicate the interface for the physical port, WAN port, LAN port and Wireless Port.

Default Class Use the drop down list to choose the priority for each port.

Default Class

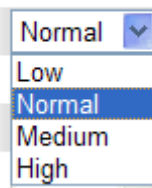

A dropdown menu showing the following options: Normal (selected), Low, Normal, Medium, High.

QCL Use the drop down list to choose the QCL number defined in QoS Control List for the port.

QCL

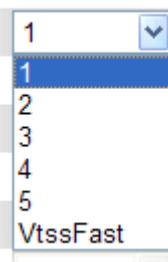

A dropdown menu showing the following options: 1 (selected), 1, 2, 3, 4, 5, VtssFast.

Queuing Mode Use the drop down list to choose suitable mode.

Queuing Mode

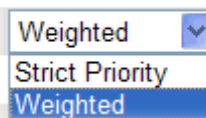

A dropdown menu showing the following options: Weighted (selected), Strict Priority, Weighted.

Queue Weighted

Use the drop down list to choose 1, 2, 4, or 8 as the queue weighted number.

3.4.6 QoS Statistics

This page displays statistics for QoS setting. Click WAN/LAN link to check detailed information for each interface.

Bandwidth Management >> QoS Statistics

Queuing Counters

Auto-refresh

Port	Low Queue		Normal Queue		Medium Queue		High Queue	
	Receive	Transmit	Receive	Transmit	Receive	Transmit	Receive	Transmit
WAN	58350	61843	69518	0	76195	63030	22	12
LAN1	0	0	0	0	0	0	0	0
LAN2	57361	7575	1953	61191	66042	75655	21	0
LAN3	0	0	0	0	0	0	0	0
LAN4	0	0	0	0	0	0	0	0

Click [WAN/LAN](#) link to check detailed information for each interface.

Diagnostics >> Detailed Statistics

Detailed Port Statistics WAN

[WAN](#) Auto-refresh

Receive Total		Transmit Total	
Rx Packets	6320	Tx Packets	2492
Rx Octets	1729133	Tx Octets	996250
Rx Unicast	3129	Tx Unicast	2489
Rx Multicast	200	Tx Multicast	0
Rx Broadcast	2991	Tx Broadcast	3
Rx Pause	0	Tx Pause	0
Receive Size Counters		Transmit Size Counters	
Rx 64 Bytes	3502	Tx 64 Bytes	1367
Rx 65-127 Bytes	1106	Tx 65-127 Bytes	433
Rx 128-255 Bytes	698	Tx 128-255 Bytes	16
Rx 256-511 Bytes	149	Tx 256-511 Bytes	82
Rx 512-1023 Bytes	58	Tx 512-1023 Bytes	27
Rx 1024-1526 Bytes	807	Tx 1024-1526 Bytes	567
Rx 1527- Bytes	0	Tx 1527- Bytes	0
Receive Queue Counters		Transmit Queue Counters	
Rx Low	4286	Tx Low	1385
Rx Normal	813	Tx Normal	0
Rx Medium	1217	Tx Medium	1107
Rx High	4	Tx High	0
Receive Error Counters		Transmit Error Counters	
Rx Drops	0	Tx Drops	0
Rx CRC/Alignment	0	Tx Late/Exc. Coll.	0
Rx Undersize	0		
Rx Oversize	0		
Rx Fragments	0		
Rx Jabber	0		
Rx Filtered	0		

Rx Packets

Display the counting number of the packet received.

Rx Octets

Display the total received bytes.

Rx Unicast

Display the counting number of the received unicast packet.

Rx Broadcast	Display the counting number of the received broadcast packet.
Rx Pause	Display the counting number of the received pause packet.
RX 64 Bytes	Display the number of 64-byte frames in good and bad packets received.
RX 65-127 Bytes	Display the number of 65 ~ 127-byte frames in good and bad packets received.
RX 128-255 Bytes	Display the number of 128 ~ 255-byte frames in good and bad packets received.
RX 256-511 Bytes	Display the number of 256 ~ 511-byte frames in good and bad packets received.
RX 512-1023 Bytes	Display the number of 512 ~ 1023-byte frames in good and bad packets received.
RX 1024- 1526 Bytes	Display the number of 1024-1522-byte frames in good and bad packets received.
RX 1527 Bytes	Display the number of 1527-byte frames in good and bad packets received.
Rx Low	Display the low queue counter of the packet received.
Rx Normal	Display the normal queue counter of the packet received.
Rx Medium	Display the medium queue counter of the packet received.
Rx High	Display the high queue counter of the packet received.
Rx Drops	Display the number of frames dropped due to the lack of receiving buffer.
Rx CRC/Alignment	Display the number of Alignment errors packets received.
Rx Undersize	Display the number of short frames (<64 Bytes) with valid CRC.
Rx Oversize	Display the number of long frames (according to max_length register) with valid CRC.
Rx Fragments	Display the number of short frames (< 64 bytes) with invalid CRC.
Rx Jabber	Display the number of long frames (according to max_length register) with invalid CRC.
Rx Filtered	Display the filtered number of the packet received.
Tx Packets	Display the counting number of the packet transmitted.
Tx Octets	Display the total transmitted bytes.
Tx Unicast	Display the show the counting number of the transmitted unicast packet.
Tx Multicast	Display the show the counting number of the transmitted multicast packet.
Tx Broadcast	Display the counting number of the transmitted broadcast packet.
Tx Pause	Show the counting number of the transmitted pause packet.

Tx 64 Bytes	Display the number of 64-byte frames in good and bad packets transmitted.
Tx 65-127 Bytes	Display the number of 65 ~ 127-byte frames in good and bad packets transmitted.
Tx 128-255 Bytes	Display the number of 128 ~ 255-byte frames in good and bad packets transmitted.
Tx 256-511 Bytes	Display the number of 256 ~ 511-byte frames in good and bad packets transmitted.
Tx 512-1023 Bytes	Display the number of 512 ~ 1023-byte frames in good and bad packets transmitted.
Tx 1024- 1526 Bytes	Display the number of 1024 ~ 1522-byt frames in good and bad packets transmitted.
Tx 1527 Bytes:	Display the number of 1527-byte frames in good and bad packets transmitted.
Tx Low	Display the low queue counter of the packet transmitted.
Tx Normal	Display the normal queue counter of the packet transmitted.
Tx Medium	Display the medium queue counter of the packet received.
Tx High	Display the high queue counter of the packet received.
Tx Drops	Display the number of frames dropped due to excessive collision, late collision, or frame aging.
Tx lat/Exc.Coll.	Display the number of Frames late collision or excessive collision Error, which switch transmitted

3.5 Applications

Below shows the menu items for Applications.



3.5.1 Dynamic DNS

The ISP often provides you with a dynamic IP address when you connect to the Internet via your ISP. It means that the public IP address assigned to your router changes each time you access the Internet. The Dynamic DNS feature lets you assign a domain name to a dynamic WAN IP address. It allows the router to update its online WAN IP address mappings on the specified Dynamic DNS server. Once the router is online, you will be able to use the registered domain name to access the router or internal virtual servers from the Internet. It is particularly helpful if you host a web server, FTP server, or other server behind the router.

Before you use the Dynamic DNS feature, you have to apply for free DDNS service to the DDNS service providers. The router provides up to three accounts from three different DDNS service providers. Basically, Vigor routers are compatible with the DDNS services supplied by most popular DDNS service providers such as www.dyndns.org, www.no-ip.com,

www.dtdns.com, www.changeip.com, www.dynamic-nameserver.com. You should visit their websites to register your own domain name for the router.

Applications >> Dynamic DNS

Dynamic DNS Configuration

Enable Dynamic DNS	<input type="checkbox"/>
Service Provider	dyndns.org
Domain name	mypersonaldomain.dyndn:
Username	myusername
Password	••••••
Check IP change every	10 minutes
Force IP update every	72 hours

- Enable Dynamic DNS** Check this box to enable the current account.
- DynDNS Service** Select the service provider for the DDNS account.
- Hostname** Type in one domain name that you applied previously. Use the drop down list to choose the desired domain.
- Username** Type in the login name that you set for applying domain.
- Password** Type in the password that you set for applying domain.
- Check IP change every** Set the interval for checking the information.
- Force IP update every** Force the router updates its information to DDNS server with the interval set here.

Click **OK** button to activate the settings. You will see your setting has been saved.

3.5.2 Schedule

The Vigor router has a built-in real time clock which can update itself manually or automatically by means of Network Time Protocols (NTP). As a result, you can not only schedule the router to dialup to the Internet at a specified time, but also restrict Internet access to certain hours so that users can connect to the Internet only during certain hours, say, business hours. The schedule is also applicable to other functions.

You have to set your time before set schedule. In **System Maintenance>> Time and Date** menu, press **Inquire Time** button to set the Vigor router's clock to current time of your PC. The clock will reset once if you power down or reset the router. There is another way to set up time. You can inquiry an NTP server (a time server) on the Internet to synchronize the router's clock. This method can only be applied when the WAN connection has been built up.

Applications >> Schedule

Schedule Configuration		
Index	Setting	Status
<input type="button" value="Add"/>		

You can set up to 15 schedules. To add a schedule profile, please click **Add**.

Applications >> Schedule

Add Schedule

<input checked="" type="checkbox"/> Enable	
Start Date	2000 - 1 - 1 (Year - Month - Date)
Start Time	0 : 0 (Hour : Minute)
Action	WAN UP
Acts	Once
Weekday	<input type="checkbox"/> Monday <input type="checkbox"/> Tuesday <input type="checkbox"/> Wednesday <input type="checkbox"/> Thursday <input type="checkbox"/> Friday <input type="checkbox"/> Saturday <input type="checkbox"/> Sunday

Enable

Check to enable the schedule.

Start Date

Specify the starting date of the schedule.

Start Time

Specify the starting time of the schedule.

Action

Specify which action should be applied during the period of the schedule.

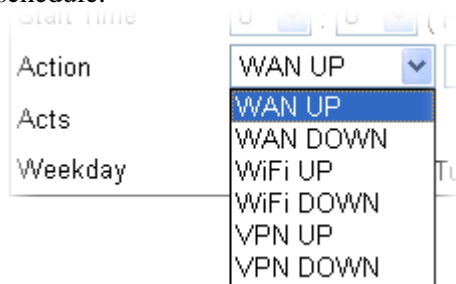

WAN UP/DOWN – WAN connection will be activated / inactivated based on the time schedule configured here.

WiFi UP/DOWN – Wireless Wi-Fi connection will be activated / inactivated based on the time schedule configured here.

VPN UP/DOWN - VPN connection will be activated / inactivated based on the time schedule configured here.

Acts

Specify how often the schedule will be applied

Once -The schedule will be applied just once

Routine or **Weekdays** -Specify which days in one week should perform the schedule.

3.5.3 IGMP Snooping

IGMP snooping means multicast traffic will be forwarded to ports that have members of that group. If you disable IGMP snooping, the system will make multicast traffic treated in the same manner as broadcast traffic.

[Applications >> IGMP Snooping](#)

IGMP Snooping Configuration

General Configuration	
Snooping Enabled	<input type="checkbox"/>
Unregistered IPMC Flooding enabled	<input type="checkbox"/>

Port Related Configuration

Port	Fast Leave
LAN1	<input type="checkbox"/>
LAN2	<input type="checkbox"/>
LAN3	<input type="checkbox"/>
LAN4	<input type="checkbox"/>

Snooping Enabled

Check the box to enable this function.

Unregistered IPMC...

Check the box to enable unregistered IPMC traffic flooding.

Fast Leave

Check the box to Fast Leave on the LAN port.

3.5.4 IGMP Status

This page display current IGMP snooping status.

[Applications >> IGMP Status](#)

IGMP Snooping Status

Auto-refresh

Statistics

V1 Reports Receive	V2 Reports Receive	V3 Reports Receive	V2 Leave Receive
0	0	0	0

IGMP Groups

Groups	Port Members
No IGMP groups	1 2 3 4

V1~3 Reports Receive

Display the number of Received V1 – V3 Reports.

V2 Leave Receive

Display the number of Received V2 Leave.

Groups

Display current IGMP groups. Maximum number of group for each VLAN can be set is 128.

Port Members

Display the LAN ports in this group.

Refresh

Click this button to refresh the page immediately.

Clear

Click this button to clear the settings on this page.

3.5.5 UPnP Configuration

The **UPnP** (Universal Plug and Play) protocol is supported to bring to network connected devices the ease of installation and configuration which is already available for directly connected PC peripherals with the existing Windows 'Plug and Play' system. For NAT routers, the major feature of UPnP on the router is "NAT Traversal". This enables applications inside the firewall to automatically open the ports that they need to pass through a router. It is more reliable than requiring a router to work out by itself which ports need to be opened. Further, the user does not have to manually set up port mappings or a DMZ. **UPnP is available on Windows XP** and the router provide the associated support for MSN Messenger to allow full use of the voice, video and messaging features.

Applications >> UPnP Configuration

UPnP Configuration

Enable UPnP	<input checked="" type="checkbox"/>
Download Speed	<input type="text" value="1024"/> kbps
Upload Speed	<input type="text" value="512"/> kbps

Enable UPNP

Enable UPnP function. You have to type the download and upload speed.

After setting **Enable UPNP Service** setting, an icon of **IP Broadband Connection on Router** on Windows XP/Network Connections will appear. The connection status and control status will be able to be activated. The NAT Traversal of UPnP enables the multimedia features of your applications to operate. This has to manually set up port mappings or use other similar methods. The screenshots below show examples of this facility.

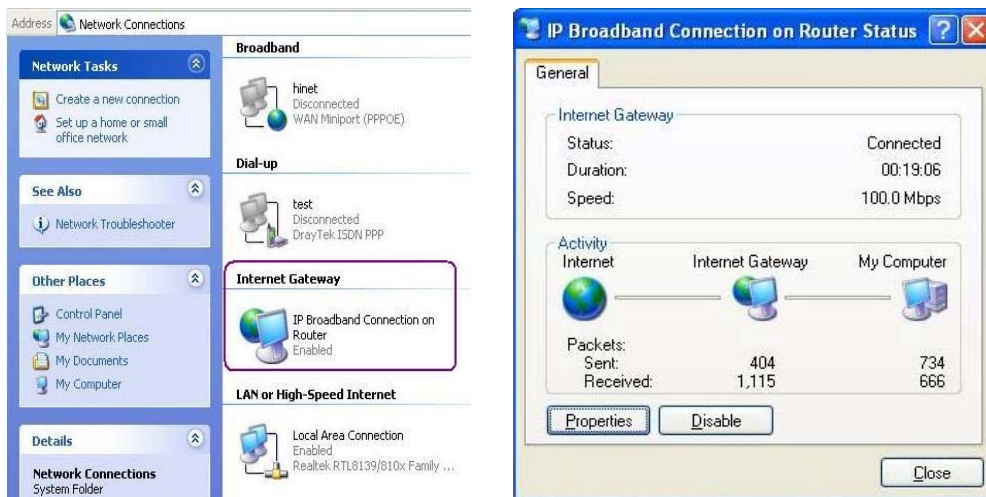

The UPnP facility on the router enables UPnP aware applications such as MSN Messenger to discover what are behind a NAT router. The application will also learn the external IP address and configure port mappings on the router. Subsequently, such a facility forwards packets from the external ports of the router to the internal ports used by the application.

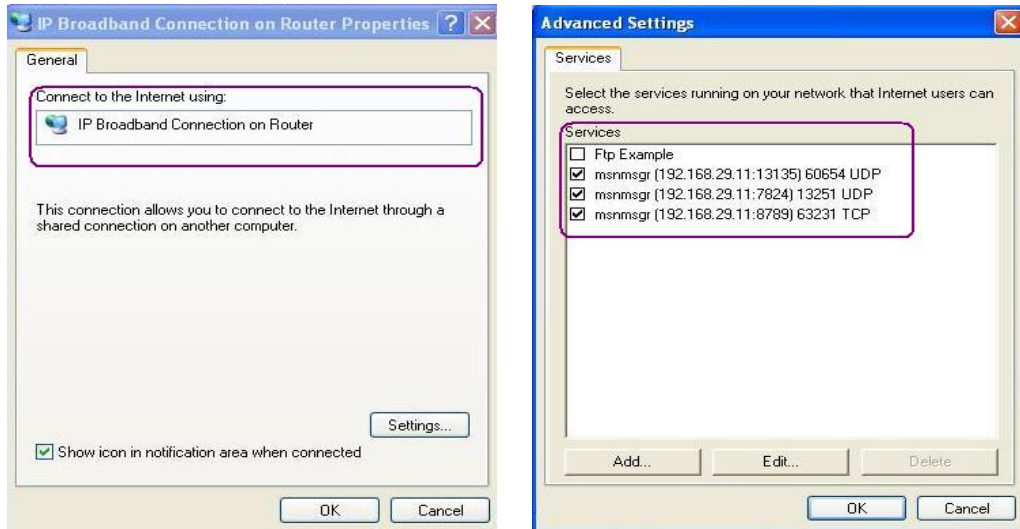

The reminder as regards concern about Firewall and UPnP

Can't work with Firewall Software

Enabling firewall applications on your PC may cause the UPnP function not working properly. This is because these applications will block the accessing ability of some network ports.

Security Considerations

Activating the UPnP function on your network may incur some security threats. You should consider carefully these risks before activating the UPnP function.

- Some Microsoft operating systems have found out the UPnP weaknesses and hence you need to ensure that you have applied the latest service packs and patches.
- Non-privileged users can control some router functions, including removing and adding port mappings.

The UPnP function dynamically adds port mappings on behalf of some UPnP-aware applications. When the applications terminate abnormally, these mappings may not be removed.

3.5.6 Wake On LAN

A PC client on LAN can be woken up by the router it connects. When a user wants to wake up a specified PC through the router, he/she must type correct MAC address of the specified PC on this web page of **Wake On LAN** of this router.

In addition, such PC must have installed a network card supporting WOL function. By the way, WOL function must be set as “Enable” on the BIOS setting.

Applications >> Wake on LAN

Wake on LAN

Note: Wake on LAN integrates with Bind IP to MAC function, only binded PCs can wake up through IP.

Wake by:

IP Address:

MAC Address: : : : : :

Result

Wake by

Two types provide for you to wake up the binded IP. If you choose **Wake by MAC Address**, you have to type the correct MAC address of the host in **MAC Address** boxes. If you choose **Wake by IP Address**, you have to choose the correct IP address.

Wake by:

IP Address

The IP addresses that have been configured in **LAN>>Bind IP to MAC** will be shown in this drop down list. Choose the IP address from the drop down list that you want to wake up.

MAC Address

Type any one of the MAC address of the binded PCs.

Wake Up

Click this button to wake up the selected IP. See the following figure. The result will be shown on the box.

3.6 Wireless LAN

This function is used for “n” models.

3.6.1 Basic Concepts

Over recent years, the market for wireless communications has enjoyed tremendous growth. Wireless technology now reaches or is capable of reaching virtually every location on the surface of the earth. Hundreds of millions of people exchange information every day via wireless communication products. The Vigor “n” model, a.k.a. Vigor wireless router, is designed for maximum flexibility and efficiency of a small office/home. Any authorized staff can bring a built-in WLAN client PDA or notebook into a meeting room for conference without laying a clot of LAN cable or drilling holes everywhere. Wireless LAN enables high mobility so WLAN users can simultaneously access all LAN facilities just like on a wired LAN as well as Internet access

The Vigor wireless routers are equipped with a wireless LAN interface compliant with the standard IEEE 802.11n draft 2 protocol. To boost its performance further, the Vigor Router is also loaded with advanced wireless technology to lift up data rate up to 300 Mbps*. Hence, you can finally smoothly enjoy stream music and video.

Note: * The actual data throughput will vary according to the network conditions and environmental factors, including volume of network traffic, network overhead and building materials.

In an Infrastructure Mode of wireless network, Vigor wireless router plays a role as an Access Point (AP) connecting to lots of wireless clients or Stations (STA). All the STAs will share the same Internet connection via Vigor wireless router. The **General Settings** will set up the information of this wireless network, including its SSID as identification, located channel etc.

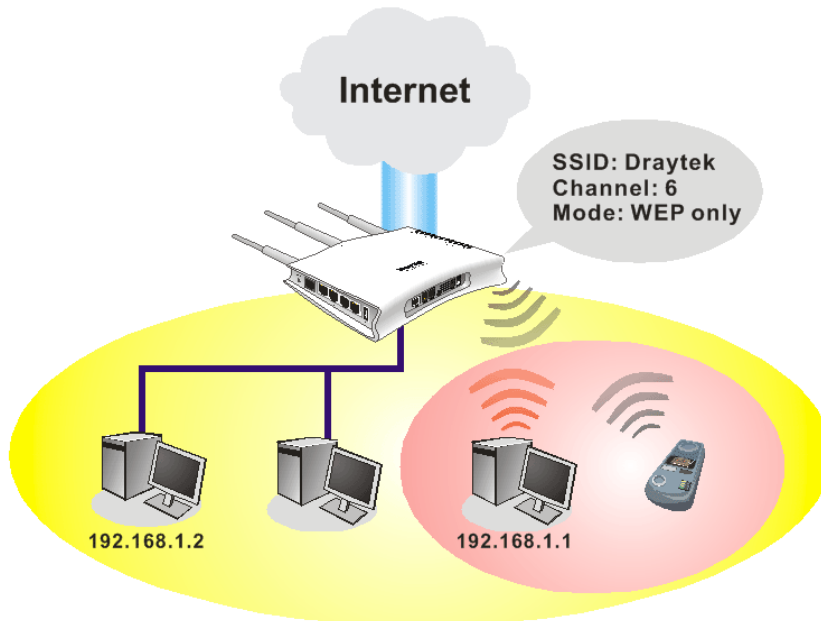

Security Overview

Real-time Hardware Encryption: Vigor Router is equipped with a hardware AES encryption engine so it can apply the highest protection to your data without influencing user experience.

Complete Security Standard Selection: To ensure the security and privacy of your wireless communication, we provide several prevailing standards on market.

WEP (Wired Equivalent Privacy) is a legacy method to encrypt each frame transmitted via radio using either a 64-bit or 128-bit key. Usually access point will preset a set of four keys and it will communicate with each station using only one out of the four keys.

WPA (Wi-Fi Protected Access), the most dominating security mechanism in industry, is separated into two categories: WPA-personal or called WPA Pre-Share Key (WPA/PSK), and WPA-Enterprise or called WPA/802.1x.

In WPA-Personal, a pre-defined key is used for encryption during data transmission. WPA applies Temporal Key Integrity Protocol (TKIP) for data encryption while WPA2 applies AES. The WPA-Enterprise combines not only encryption but also authentication.

Since WEP has been proved vulnerable, you may consider using WPA for the most secure connection. You should select the appropriate security mechanism according to your needs. No matter which security suite you select, they all will enhance the over-the-air data protection and /or privacy on your wireless network. The Vigor wireless router is very flexible and can support multiple secure connections with both WEP and WPA at the same time.

Below shows the menu items for Wireless LAN.

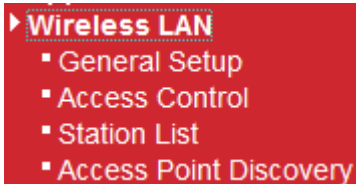

3.6.2 General Setup

By clicking the **General Setup**, a new web page will appear so that you could configure the SSIDs and the wireless channel.

Please refer to the following figure for more information.

Wireless LAN >> General Setup

General Setting

Enable Wireless LAN	<input checked="" type="checkbox"/>	Show/Hide	SSID	Isolate
SSID 1	<input checked="" type="checkbox"/>	Show <input type="button" value="v"/>	DrayTek	<input type="checkbox"/>
SSID 2	<input type="checkbox"/>	Show <input type="button" value="v"/>	DrayTek2	<input type="checkbox"/>
SSID 3	<input type="checkbox"/>	Show <input type="button" value="v"/>	DrayTek3	<input type="checkbox"/>
SSID 4	<input type="checkbox"/>	Show <input type="button" value="v"/>	DrayTek4	<input type="checkbox"/>
Wireless Mode	Mixed (11b+11g+11n) <input type="button" value="v"/>			
Channel	Channel 11, 2462MHz <input type="button" value="v"/>			
Tx Power	100% <input type="button" value="v"/>			
Enable Green AP	<input type="checkbox"/>			

Isolate: Wireless clients (stations) with the same SSID cannot access for each other.



Wireless Security Configuration

Encryption	None <input type="button" value="v"/>
------------	---------------------------------------

Enable Wireless LAN

Check the box to enable the wireless function.

SSID Broadcast

Choose **Show** to make the SSID being seen by wireless clients. Choose **Hide** to prevent from wireless sniffing and make it harder for unauthorized clients or STAs to join your wireless LAN.

SSID

It means the identification of the wireless LAN. SSID can be any text numbers or various special characters. The default SSID is "DrayTek". We suggest you to change it.

Isolate

Check this box to make the wireless clients (stations) with the same SSID not accessing for each other.

Wireless Mode

Choose the wireless mode for this router. At present, only 802.11B/B/N mix is available.

Channel

It means the channel of frequency of the wireless LAN. The default channel is 11. You may switch channel if the selected channel is under serious interference. If you have no idea of choosing the frequency, please select **Auto** to let system determine for you.

Tx Power

Set the power percentage for transmission signal of access point. The greater the value is, the higher intensity of the signal will be.

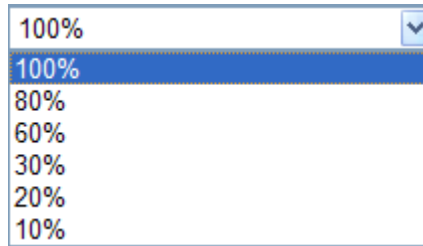

A dropdown menu for Tx Power with the following options: 100% (selected), 80%, 60%, 30%, 20%, and 10%.

Enable Green AP

Such function is used to reduce the power consumption (Green AP) for the access point. When there is no station connected, the power consumption of access point will be reduced.

Encryption

Select an appropriate encryption mode to improve the security and privacy of your wireless data packets.

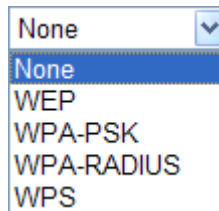

A dropdown menu for Encryption with the following options: None (selected), WEP, WPA-PSK, WPA-RADIUS, and WPS.

Each encryption mode will bring out different web page and ask you to offer additional configuration.

Wireless Security Configuration

For the security of your system, choose the proper encryption for data transmission. Different encryption mode will bring out different setting encryption ways.

- **None**

The encryption mechanism is turned off.

- **WEP**

Accepts only WEP clients and the encryption key should be entered in WEP Key.

Wireless Security Configuration



Encryption: WEP

WEP Configuration



Default Key: Key1
Key1:
Key2:
Key3:
Key4:
Authentication Mode: OPEN



OK Cancel

Default Key

All wireless devices must support the same WEP encryption bit size and have the same key.

Key1-Key4

Four keys can be entered here, but only one key can be selected at a time. The format of WEP Key is restricted to 5 ASCII characters or 10 hexadecimal values in 64-bit encryption level, or restricted to 13 ASCII characters or 26 hexadecimal values in 128-bit encryption level. The allowed content is the ASCII characters from 33(!) to 126(~) except '#' and ' '.

Authentication Mode

Choose **OPEN** or **SHARED** as the authentication mode.
OPEN: Set wireless to authentication open mode.
SHARED: Set wireless to authentication shared mode.

- **WPA-PSK**

Accepts only WPA clients and the encryption key should be entered in PSK. The WPA encrypts each frame transmitted from the radio using the key, which either PSK (Pre-Shared Key) entered manually in this field below or automatically negotiated via 802.1x authentication.

Wireless Security Configuration

Encryption	WPA-PSK
------------	---------

WPA-PSK Configuration

Type	WPA
WPA Algorithm	TKIP
WPA Pre-Shared Key	

OK Cancel

WPA Mode

Select WPA, WPA2 or Auto as the type.

WPA
WPA
WPA2
Auto(WPA or WPA2)

WPA Algorithm

Select TKIP, AES or auto as the algorithm for WPA.

TKIP
TKIP
AES
Auto(TKIP or AES)

WPA Pre-Shared Key

Either **8~63** ASCII characters, such as 012345678..(or 64 Hexadecimal digits leading by 0x, such as "0x321253abcde...").

- **WPA-RADIUS**

The built-in RADIUS client feature enables the router to assist the remote dial-in user or a wireless station and the RADIUS server in performing mutual authentication. It enables centralized remote access authentication for network management.

Wireless Security Configuration

Encryption	WPA-RADIUS
------------	------------

WPA-RADIUS Configuration

Type	WPA
WPA Algorithm	TKIP
Server IP Address	0.0.0.0
Destination Port	1812
Shared Secret	radius_secret

Type

The WPA encrypts each frame transmitted from the radio using the key, which either PSK (Pre-Shared Key) entered manually in this field below or automatically negotiated via 802.1x authentication. Select WPA, WPA2 or Auto as WPA mode.

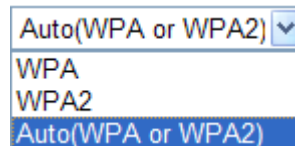

WPA Algorithm

Choose the WPA algorithm, TKIP, AES or Auto.

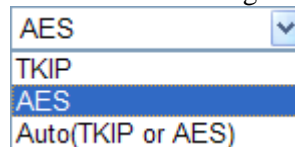

Server IP Address

Enter the IP address of RADIUS server.

Destination Port

The UDP port number that the RADIUS server is using. The default value is 1812, based on RFC 2138.

Shared Secret

The RADIUS server and client share a secret that is used to authenticate the messages sent between them. Both sides must be configured to use the same shared secret.

- **WPS**

WPS (Wi-Fi Protected Setup) provides easy procedure to make network connection between wireless station and wireless access point (vigor router) with the encryption of WPA and WPA2.

Wireless Security Configuration

Encryption	WPS
------------	-----

WPS Configuration

Configure via Push Button	<input type="button" value="Start PBC"/>
Configure via Client PinCode	<input type="text"/> <input type="button" value="Start PIN"/>

Configure via Push Button

Click **Start PBC** to invoke Push-Button style WPS setup procedure. The router will wait for WPS requests from wireless clients about two minutes. The WPS LED on the

router will blink fast when WPS is in progress. It will return to normal condition after two minutes. (You need to setup WPS within two minutes)

Configure via Client PinCode Type the PIN code specified in wireless client you wish to connect, and click **Start PIN** button. The WLAN LED on the router will blink fast when WPS is in progress. It will return to normal condition after two minutes. (You need to setup WPS within two minutes)

It is the simplest way to build connection between wireless network clients and vigor router. Users do not need to select any encryption mode and type any long encryption passphrase to setup a wireless client every time. He/she only needs to press a button on wireless client, and WPS will connect for client and router automatically.

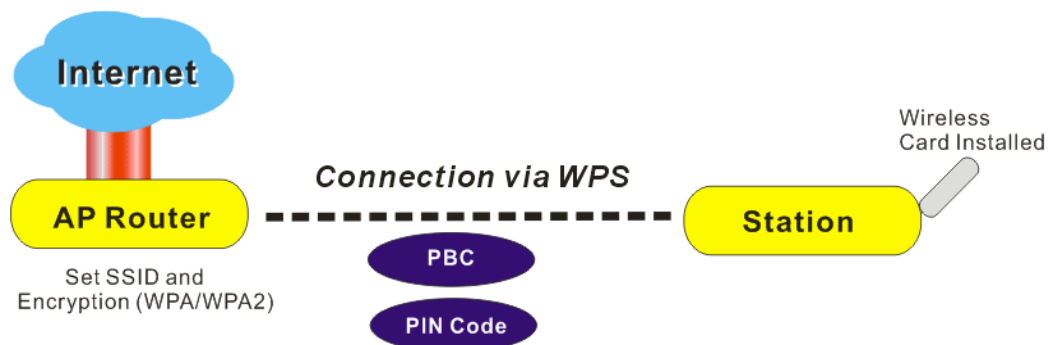

Note: Such function is available for the wireless station with WPS supported.

There are two methods to do network connection through WPS between AP and Stations: pressing the **Start PBC** button or using **PIN Code**.

On the side of Vigor 2130 series which served as an AP, press **WPS** button once on the front panel of the router or click **Start PBC** on web configuration interface. On the side of a station with network card installed, press **Start PBC** button of network card.

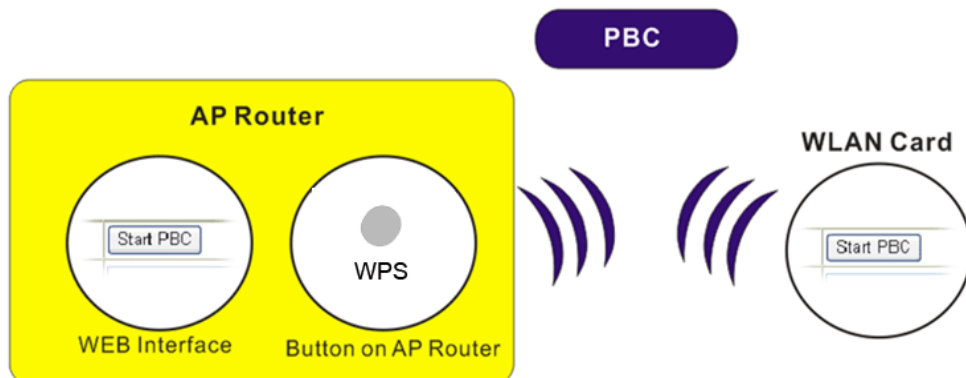

If you want to use PIN code, you have to know the PIN code specified in wireless client. Then provide the PIN code of the wireless client you wish to connect to the vigor router.

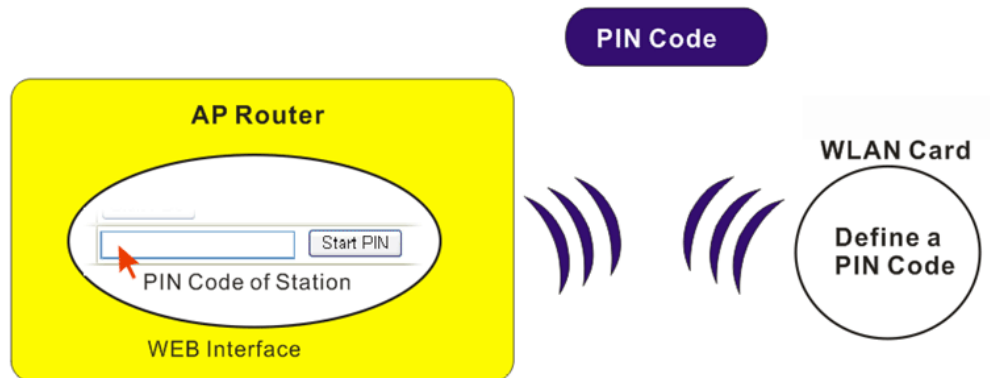

3.6.3 Access Control

For additional security of wireless access, the **Access Control** facility allows you to restrict the network access right by controlling the wireless LAN MAC address of client. Only the valid MAC address that has been configured can access the wireless LAN interface. By clicking the **Access Control**, a new web page will appear, as depicted below, so that you could edit the clients' MAC addresses to control their access rights (deny or allow).

Wireless LAN >> Access Control

Wireless MAC Address Filter Configuration

SSID 1	SSID 2	SSID 3	SSID 4
Filter Type			Deny List
Delete		MAC Address	

Note: Each SSID up to 64 MAC address at one time.

Add a New Entry

OK

Filter Type

Choose the rule for the MAC addresses displayed in this page.

Allow List – all the MAC address of wireless clients listed here are allowed to do wireless connection.

Deny List – all the MAC address of wireless clients listed here will be blocked.

Add a New Entry

Add a new MAC address into the list.

Delete

Delete the selected MAC address in the list. This button will appear only an entry of MAC Address has been typed.

Delete	MAC Address
Delete	00:20:00:05:30:12
Add a New Entry	

OK Cancel

Cancel

Give up the configuration.

OK

Click it to save the configuration.

3.6.4 Station List

Station List provides the knowledge of connecting wireless clients now along with its status code.

Wireless LAN >> Station List

Station List

Auto-refresh Refresh

Index	IP Address	MAC Address	Connected Time	SSID
<i>No Station</i>				

Index

Display the number of the connecting client.

IP Address

Display the WAN IP address for the connecting client.

MAC Address

Display the MAC Address for the connecting client.

Connected Time

Display the connection time for the connecting client.

SSID

Display the SSID that the station(s) connected through.

Auto-refresh

Check this box to force the system refreshing the table automatically.

Refresh

Click this button to refresh current page.

3.6.5 Access Point Discovery

Vigor router can scan all regulatory channels and find working APs in the neighborhood. Based on the scanning result, users will know which channel is clean for usage.

Note: During the scanning process (about 5 seconds), no client is allowed to connect to Vigor.

The table will list channel, SSID, BSSID, Security and the Signal strength of working APs in the neighborhood.

Wireless LAN >> Access Point Discovery

Access Point Discovery

CH	SSID	BSSID	Security	Signal(%)
----	------	-------	----------	-----------

Note: During the scanning process (~5 seconds), no station is allowed to connect with the router.

CH	Display the channel for the scanned AP.
SSID	Display the SSID of the scanned AP.
BSSID	Display the MAC address of the scanned AP.
Security	Display the encryption type of the scanned AP.
Signal	Display the strength (in percentage) of the signal of the scanned AP.
Scan	It is used to discover all the connected AP. The results will be shown on the box above this button.

3.7 USB Application

USB diskette can be regarded as an FTP server. By way of Vigor router, users on LAN/WAN can access, write and read data stored in USB diskette. After setting the configuration in **USB Application**, you can type the IP address of the Vigor router and username/password created in **USB Application>>FTP User Management** on the FTP client software. Thus, the client can use the FTP site (USB diskette) through Vigor router.

- ▶ **USB Application**
 - USB General Settings
 - FTP User Management
 - Disk Status
 - Disk Shares

3.7.1 USB General Settings

At present, the Vigor router can support USB diskette with versions of FAT16 and FAT32 only. Therefore, before connecting the USB diskette into the Vigor router, please make sure the memory format for the USB diskette is FAT16 or FAT32. It is recommended for you to use FAT32 for viewing the filename completely (FAT16 cannot support long filename).

USB Application >> USB General Settings

USB General Settings

Enable FTP	<input type="checkbox"/>
Enable Disk Sharing	<input type="checkbox"/>
Workgroup Name	<input type="text" value="WORKGROUP"/>

Enable FTP

Check this box to enable FTP connection.

Enable Disk Sharing

Check this box to enable Samba file sharing.

Workgroup Name

Type the name for FTP users for accessing into FTP server (USB diskette). Be aware that users cannot access into USB diskette in anonymity. Later, you can open FTP client software and type the username specified here for accessing into USB storage diskette.

3.7.2 FTP User Management

This page allows you to change user setting for USB storage disk. Before modifying settings in this page, please insert a USB diskette and configure settings in **User>>User Configuration** first. Otherwise, an error message will appear to warn you.

USB Application >> FTP User Management

FTP User Management

User Name	Volume	Path	Access Rights
carrie	--	--	Read-only

Click the name link under User Name to open the setting web page.

USB Application >> FTP User Setting

FTP User Configuration

User Name	carrie
Volume	USB2.0 - Mobile Disk (1) - 1967M - PORT 1 ▾
Home Folder	<input type="text" value="/"/>
Access Rule	Read-only ▾

User Name

It displays the username that user uses to login to the FTP server.

Volume

Select the proper volume for the connected USB diskette.

Home Folder

It determines the range for the client to access into. The user can enter a directory name in this field. Then, after clicking **OK**, the router will create the specific/new folder in the USB diskette. In addition, if the user types “/” here, he/she can access into all of the disk folders and files in USB diskette.

Note: When write protect status for the USB diskette is **ON**, you cannot type any new folder name in this field. Only “/” can be used in such case.

Access Rule

Select the access right for the USB diskette.

Read-only ▼
 Read-only
 Read-write

When you finish the settings, simply click OK to save the configuration.

3.7.3 Disk Status

This page can display current using status of the USB diskette. If you want to remove the diskette from USB port in router, please check the box of Safely Remove Disk first. And then, remove the USB diskette later.

USB Application >> Disk Status

Disk Status

Safely Remove Disk	Manufacturer	Model	Size	Free Capacity	Status
<input type="checkbox"/>	Generic	Flash Disk	2011M	1.6G	In use

Update

- Safely Remove Disk** Check this box and then you can remove the USB diskette safely.
- Manufacturer** Display the manufacturer of the disk.
- Model** Display the type of the disk.
- Size** Display the storage space of the diskette(s).
- Free Capacity** Display the free disk space of the diskette(s).
- Status** Display current usage status of the diskette(s)
- Update** Click this button to refresh the disk status.

3.7.4 Disk Shares

This page can define the folder which will be shared while Samba File Sharing is enabled.

USB Application >> Disk Shares

Disk Shares

Share Name	Comment	Path	Visible
No Shares			

Add a New Entry

To add a new entry for disk sharing, please click **Add a New Entry** to open the following page.

USB Application >> Disk Share

Add Disk Share

Identification

Share Name	<input type="text"/>
Comment	<input type="text"/>

Settings

Volume	USB2.0 - Mobile Disk (1) - 1967M - PORT 1 ▾
Path	<input type="text" value="/"/>
Visible	<input type="checkbox"/>

Access Rights

Access	All Users Read-only ▾
--------	-----------------------

OK Cancel

- Share Name** Type a name to be used as shared folder name in Samba service. The name must not contain spaces or special characters.
- Comment** Type the brief description for the disk sharing. The words here will be seen in Network Neighborhood on Windows client computers
- Volume** Select the proper volume for the connected USB diskette.
- Path** It determines the range for the client to access into. The user can enter a directory name in this field. Then, after clicking **OK**, the router will create the specific/new folder in the USB diskette. In addition, if the user types “/” here, he/she can access into all of the disk folders and files in USB diskette.
Note: When write protect status for the USB diskette is **ON**, you cannot type any new folder name in this field. Only “/” can be used in such case.
- Visible** Check this box to make the shared folder to be seen in Network Neighborhood on Windows of clients in local network.
- Access Rights** Specify the access right and apply to all the wireless clients that want to connect to the attached USB diskette.

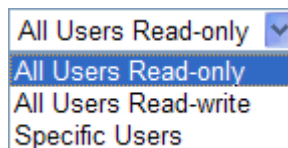

All Users Read-only ▾
All Users Read-only
All Users Read-write
Specific Users

All Users Read-only - everyone has read-only access to the share disk.

All Users Read-write - everyone has read-write access to the share disk.

Specific Users – Only specific user(s) can access into the share disk.

3.8 IPv6



3.8.1 IPv6 WAN Setup

This page defines the IPv6 connection types for WAN interface. Possible types contain Link-Local only, Static IPv6, DHCPv6 and TSPC. Each type requires different parameter settings.

IPv6 >> WAN General Setup

WAN IPv6 Configuration

IPv6 Connection Type	Link-Local Only
----------------------	-----------------

Link-Local Only

IPv6 Address	fe80::250:ff:fe00:2
Prefix Length	64

OK

WAN IPv6 Configuration

IPv6 Connection Type	Link-Local Only
Link-Local Only	Link-Local Only
Static IPv6	Static IPv6
DHCPv6 Client (IA_NA)	DHCPv6 Client (IA_NA)
TSPC	TSPC
DHCPv6 Client (IA_PD)	DHCPv6 Client (IA_PD)

Link-Local Only

IPv6 Address	
Prefix Length	

Link-Local Only

Link-Local address is used for communicating with neighbouring nodes on the same link. It is defined by the address prefix **fe80::/10**. You don't need to setup Link-Local address manually for it is generated automatically according to your MAC Address.

IPv6 >> WAN General Setup

WAN IPv6 Configuration

IPv6 Connection Type	Link-Local Only
----------------------	-----------------

Link-Local Only

IPv6 Address	fe80::250:ff:fe00:2
Prefix Length	64

OK

IPv6 Address The least significant 64 bits are usually chosen as the interface hardware address constructed in modified EUI-64 format.

Prefix Length Display the fixed value (64) for prefix length.

Static IPv6

This type allows you to setup static IPv6 address for WAN.

IPv6 >> WAN General Setup

WAN IPv6 Configuration

IPv6 Connection Type	Static IPv6
----------------------	-------------

Static IPv6

IPv6 Address	<input type="text"/>
Prefix Length	<input type="text" value="0"/>
Gateway IPv6 Address	<input type="text"/>
Primary DNS Server	<input type="text"/>
Secondary DNS Server	<input type="text"/>

OK

IPv6 Address Type your IPv6 static IP here.

Prefix Length Type your IPv6 address prefix length here.

Gateway IPv6 Server Type your IPv6 gateway address here.

Primary DNS Server Type your IPv6 primary DNS Server address here.

Secondary DNS Server Type your IPv6 secondary DNS Server address here.

DHCPv6 Client (IA_NA)

DHCPv6 client mode would use IA_NA option of DHCPv6 protocol to obtain IPv6 address from server.

IPv6 >> WAN General Setup

WAN IPv6 Configuration

IPv6 Connection Type DHCPv6 Client (IA_NA) ▾

DHCPv6

User defined DNS server

Primary DNS Server

Secondary DNS Server

OK

Primary DNS Server

Type primary DNS Server address here.

Secondary DNS Server

Type secondary DNS Server address here

DHCPv6 Client (IA_PD)

DHCPv6 client mode would use IA_PA option of DHCPv6 protocol to obtain IPv6 prefix from server.

IPv6 >> WAN General Setup

WAN IPv6 Configuration

IPv6 Connection Type DHCPv6 Client (IA_PD) ▾

OK

TSPC

Tunnel setup protocol client (TSPC) is an application which could help you to connect to IPv6 network easily.

Please make sure your IPv4 WAN connection is OK and apply one free account from hexage (<http://go6.net/4105/register.asp>) before you try to use TSPC for network connection. TSPC would connect to tunnel broker and requests a tunnel according to the specifications inside the configuration file. It gets a public IPv6 IP address and an IPv6 prefix from the tunnel broker and then monitors the state of the tunnel in background.

After getting the IPv6 prefix and starting router advertisement daemon (RADVD), the PC behind this router can directly connect to IPv6 the Internet.

IPv6 >> WAN General Setup

WAN IPv6 Configuration

IPv6 Connection Type	TSPC
----------------------	------

TSPC

User Name :	vigor2130
Password :	●●●●●●●●
Confirm Password :	
Tunnel Broker :	broker.freenet6.net
Tunnel mode :	IPv6-in-IPv4 Tunnel
Auto-reconnect Delay :	30
Keepalive :	<input checked="" type="radio"/> Yes <input type="radio"/> No
keepalive_interval :	30
Prefixlen :	56
If_prefix :	br-lan

OK

Username Type the name obtained from the broker. “vigor2130” is a default username applied from <http://go6.net/4105/register.asp>. It is suggested for you to apply another username and password.

Password Type the password assigned with the user name.

Confirm Password Type the password again to make the confirmation.

Tunnel Broker Type the address for the tunnel broker IP, FQDN or an optional port number.

Tunnel Mode **IPv6-in-IPv4 Tunnel**- Let the broker choose the tunnel mode appropriate for the client.

IPv6-in-IPv4 (Native) - Request an IPv6 in IPv4 tunnel.

IPv6-in-IPv4 (NAT Traversal) - Request an IPv6 in UDP of IPv4 tunnel (for clients behind a NAT).

IPv6-in-IPv4 (NAT Traversal)
IPv6-in-IPv4 Tunnel
IPv6-in-IPv4 (Native)
IPv6-in-IPv4 (NAT Traversal)

Auto-reconnect Delay After passing the time set here, the client will retry to connect in case of failure or keepalive timeout. 0 means not retry.

Keepalive **Yes** – Keep the connection between TSPC and tunnel broker always on. TSPC will send ping packet to make sure the connection between both ends is normal.
No - The client will not send keepalives.

Keepalive_interval Type the time for the interval between two keepalive messages transferring from the client to the broker.

Prefixlen	Type the required prefix length for the client network.
If_prefix	Display LAN interface name. The name of the OS interface that will be configured with the first 64 of the received prefix from the broker and the router advertisement daemon is started to advertise that prefix on the if_prefix interface.

3.8.2 IPv6 LAN Setup

This page defines the IPv6 connection types for LAN interface. Possible types contain DHCPv6 and RADVD. Each type requires different parameter settings.

IPv6 >> LAN General Setup

LAN IPv6 Configuration

IPv6 Address	<input type="text" value="2000::1"/>	/64
IPv6 Link_local Address	<input type="text" value="fe80::200:ff:fe00:0"/>	

IPv6 Address Autoconfiguration

<input checked="" type="checkbox"/> Enable Autoconfiguration	
Configuration Type	<input type="text" value="DHCPv6 Server"/>

DHCPv6 (Stateful)

IPv6 Start Address	<input type="text" value="2000:0:0:0::10"/>	/64
IPv6 End Address	<input type="text" value="2000:0:0:0::FF"/>	/64

OK

IPv6 Address	Type static IPv6 address for LAN.
IPv6 Link_local Address	It is used for communicating with neighbouring nodes on the same link. It is defined by the address prefix fe80::/10. You don't need to setup Link-Local address manually for it is generated automatically according to your MAC Address.
Enable Autoconfiguration	Check this box to enable the auto-configuration function for IPv6 connection.
Configuration Type	Vigor2130 provides 2 daemons for LAN side IPv6 address configuration. One is RADVD (stateless) and the other is DHCPv6 Server (Stateful). DHCPv6 Server - DHCPv6 Server could assign IPv6 address to PC according to the Start/End IPv6 address configuration.

DHCPv6 (Stateful)

IPv6 Start Address	2000:0:0:0:	<input type="text"/>	/64
IPv6 End Address	2000:0:0:0:	<input type="text"/>	/64

OK

IPv6 Start Address/IPv6 End Address- Type the start and end address for IPv6 server.

RADVD - The router advertisement daemon (radvd) sends Router Advertisement messages, specified by RFC 2461, to a local Ethernet LAN periodically and when requested by a node sending a Router Solicitation message. These messages are required for IPv6 stateless autoconfiguration.

RADVD (Stateless)

Advertisement lifetime	<input type="text" value="30"/>	(minutes)
------------------------	---------------------------------	-----------

OK

Advertisement Lifetime - The lifetime associated with the default router in units of seconds. It's used to control the lifetime of the prefix. The maximum value corresponds to 18.2 hours. A lifetime of 0 indicates that the router is not a default router and should not appear on the default router list.

3.8.3 IPv6 Firewall Setup

This page allows users to set firewall for the protocol of IPv6.

Note: Section 4.4 **Firewall** is configured for IPv4 packets only.

IPv6 >> IPv6 Firewall

IPv6 Firewall List

Name	Protocol	Source IP	Destination IP	Source Port	Destination Port	Action
------	----------	-----------	----------------	-------------	------------------	--------

Name	Display the name of the rule.
Protocol	Display the protocol (TCP/UDP/ICMPv6) the rule uses.
Source IP	Display the source IP address of such rule.
Destination IP	Display the destination IP address of such rule.
Source Port	Display the source port number of such rule.
Destination Port	Display the destination port number of such rule.
Action	Display the status (accept or drop) of such rule.

Adding a New Rule

Click **Add New Rule** to configure a new rule for IPv6 Firewall.

Note: You can set up to 20 sets of IPv6 rules.

[IPv6 >> IPv6 Firewall Setup](#)

Add IPv6 Firewall Rule

Name	<input type="text"/>
Protocol	ALL <input type="button" value="v"/>
Source IP Type	None <input type="button" value="v"/>
Source IP	<input type="text"/>
Source Subnet	<input type="text"/> / 64
Destination IP Type	None <input type="button" value="v"/>
Destination IP	<input type="text"/>
Destination Subnet	<input type="text"/> / 64
Source Start Port	<input type="text"/>
Source End Port (optional)	<input type="text"/>
Destination Start Port	<input type="text"/>
Destination End Port (optional)	<input type="text"/>
Action	ACCEPT <input type="button" value="v"/>

OK

Cancel

Name

Type a name for the rule.

Protocol

Specify a protocol for this rule.

ALL <input type="button" value="v"/>
ALL
TCP
UDP
ICMPv6

Source IP Type

Determine the IP type as the source.

None <input type="button" value="v"/>
None
Single
Subnet

Source IP

Type the IP address here if you choose **Single** as **Source IP Type**.

Source Subnet

Type the subnet mask here if you choose **Subnet** as **Source IP Type**.

Destination IP Type

Determine the IP type as the destination.

None <input type="button" value="v"/>
None
Single
Subnet

Destination IP

Type the IP address here if you choose **Single** as **Destination IP Type**.

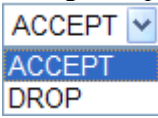
Destination Subnet	Type the subnet mask here if you choose Subnet as Destination IP Type .
Source Start Port	Type a value as the source start port. Such value will be available only TCP/UDP is selected as the protocol.
Source End Port (optional)	Type a value as the source end port. Such value will be available only TCP/UDP is selected as the protocol.
Destination Start Port	Type a value as the destination start port. Such value will be available only TCP/UDP is selected as the protocol.
Destination End Port (optional)	Type a value as the destination end port. Such value will be available only TCP/UDP is selected as the protocol.
Action	Set the action that the router will perform for the packets through the protocol of IPv6.  Accept – If the IPv6 packets fit the condition listed in this page, the router will let it pass through. Drop - If the IPv6 packets fit the condition listed in this page, the router will block it.

3.8.4 IPv6 Routing

This page displays the routing table for the protocol of IPv6.

[IPv6 >> IPv6 Routing Table](#)

IPv6 Routing Table

Auto-refresh

Device	Prefix	Metric	Expires	MTU	Advmss	Hoplimit
eth0	2000::/64	256	-1247sec	1500	1440	4294967295
eth1	fe80::/64	256	-1290sec	1500	1440	4294967295
br-lan	fe80::/64	256	-1289sec	1500	1440	4294967295
eth0	fe80::/64	256	-1288sec	1500	1440	4294967295
fp	fe80::/64	256	-1269sec	1500	1440	4294967295

Device	Display the interface name (eth0, eth1, fp, etc..)that used to transfer packets with addresses matching the prefix.
Prefix	The IPv6 address prefix.
Metric	Display the distance to the target (usually counted in hops). It is not used by recent kernels, but may be needed by routing daemons.
Expires	Display the lifetime of the route.
MTU	Display the largest size (in bytes) of a packet.
Advmss	Display the largest size (in bytes) of an unfragmented piece of a routing advertisement.

Hoplimit	Display the number of network segments on which the packet is allowed to travel before discarded.
Auto-refresh	Check this box to enable an automatic refresh of the page at regular intervals.

3.8.5 IPv6 Neighbour

IPv6 uses neighbor discovery protocol to find out neighbors on the same link.

IPv6 >> IPv6 Neighbour

IPv6 ARP Table

Auto-refresh Refresh

Device	IP Address	Mac Address	State
--------	------------	-------------	-------

Device	The interface name of the link where the neighbor is on.
IP Address	The IPv6 address of the neighbor.
MAC Address	The link-layer address of the neighbor.
State	<p>Possible states include:</p> <p>incomplete - address resolution is in progress.</p> <p>reachable - neighbor is reachable.</p> <p>stale – neighbor(s) may be unreachable but not verified until a packet is sent).</p> <p>delay - neighbor may be unreachable and a packet was sent.</p> <p>probe - neighbor may be unreachable and probes are sent to verify the reachability.</p>
Auto-refresh	Check this box to enable an automatic refresh of the page at regular intervals.

3.8.6 IPv6 TSPC Status

IPv6 TSPC status web page could help you to diagnose the connection status of TSPC. TSPC log contains some debug information from program.

If TSPC has not configured properly, the router will display the following page when the user tries to connect through TSPC connection.

IPv6 >> IPv6 TSPC Status

Status
Log

Connection Status

Tunnel Information

Tunnel Status :

Activity

Disconnected

Sent

0

|

Received

0

When TSPC configuration has been done, the router will start to connect. The connecting page will be shown as below:



When the router detects all the information, the screen will be shown as follows. One set of **TSPC prefix** and **prefix length** will be obtained after the connection between TSPC and Tunnel broker built.



Connection Status

It will bring out different pages to represent IPv6 disconnection, connecting and connected.

Tunnel Information

Display interface name (used to send TSPC prefix), tunnel mode, local endpoint addresses, remote endpoint address, TSPC Prfix, TSPC Prefixlen (prefix length), tunnel broker and so on.

Tunnel Status

Disconnected - The remote client doesn't connect to the tunnel server.
Connecting - The remote client is connecting to the tunnel server.
Connected – The remote client has been connected to the tunnel server.

Activity

Sent - sent to the tunnel (RX bytes).
Received - received from the tunnel (RX bytes).

When the router connects to the tunnel broker, the router will use RADVD to transmit the prefix to the PC on LAN. Next, the PC will generate one set of IPv6 public IP (see the figure below). Users can use such IP for connecting to IPv6 network.

```
Microsoft Windows XP [版本 5.1.2600]
(C) Copyright 1985-2001 Microsoft Corp.

C:\Documents and Settings\user>ipconfig

Windows IP Configuration

Ethernet adapter 區域連線:

    Connection-specific DNS Suffix . : 
    IP Address . . . . . : 192.168.1.100
    Subnet Mask . . . . . : 255.255.255.0
    IP Address . . . . . : 2001:5c0:1503:7400:d9c1:a2e3:4c52:1458
    IP Address . . . . . : 2001:5c0:1503:7400:21b:fcff:feda:70f6
    IP Address . . . . . : fe80::21b:fcff:feda:70f6%9
    Default Gateway . . . . . : 192.168.1.1
                                fe80::250:7fff:fe38:6135%9
```

When your PC obtains the IPv6 address, please connect to <http://www.ipv6.org>. If your PC access Internet via IPv6 connection, your IPv6 address will be shown on the web page immediately. Refer to the following figure.

IPv6

Welcome to the IPv6 Information Page!

You are using IPv6 from 2001:5c0:1503:7400:adce:274a:704:f9ec

CONTENTS

- | | |
|---|---|
| How To | FAQ |
| IPv6 enabled applications | IPv6 accessible servers |
| IPv6 specifications | Implementations |
| Mailing List | Other Site |

3.9 User

3.9.1 User Configuration

This page allows you to set user's setting that allowed to use PPTP, FTP, IPSEC/L2TP connection.

Users

Users

Username	Full Name	Allow Disk Sharing	Allow IPSEC/L2TP	Allow PPTP	Allow FTP
No users defined					

Add a New User

Adding a New User

Click **Add a New User** to open the following page.

User Configuration

Add User

User Settings	
Username	<input type="text" value="carrie"/>
Full Name	<input type="text" value="carrie ni"/>
Password	<input type="password" value="••••••••"/>
Confirm Password	<input type="password" value="••••••••"/>
Allow Disk Sharing	<input checked="" type="checkbox"/>
Allow IPSEC/L2TP	<input checked="" type="checkbox"/>
Allow PPTP	<input checked="" type="checkbox"/>
Allow FTP	<input checked="" type="checkbox"/>

OK

Cancel

Username	Type a name for this user.
Full Name	Type full name for this user.
Password	Type the password for this user.
Password (again)	Type the password again for confirmation.
Allow Disk Sharing	Check this box to enable Samba file sharing.
Allow IPSEC/L2TP	Check this box to let the user connect via IPSEC/L2TP.
Allow PPTP	Check this box to let the user connect via PPTP.
Allow FTP	Check this box to let the user connect to FTP server.

When you finish the settings, simply click **OK** to save the configuration. The new user will be created and displayed on the page.

Users

Users

Username	Full Name	Allow Disk Sharing	Allow IPSEC/L2TP	Allow PPTP	Allow FTP
carrie	carrie ni	✓	✓	✓	✓

Add a New User

Editing/Deleting User Settings

To edit a user, click the name link under Username to open the following page. Modify the settings except Username and then click **OK** to save and exit it. If you want to remove such user settings, simply click **Delete User**.

User Configuration

Edit User

User Settings	
Username	<input type="text" value="carrie"/>
Full Name	<input type="text" value="carrie ni"/>
Password	<input type="password" value="••••"/>
Confirm Password	<input type="password" value="••••"/>
Allow Disk Sharing	<input type="checkbox"/>
Allow IPSEC/L2TP	<input type="checkbox"/>
Allow PPTP	<input type="checkbox"/>
Allow FTP	<input type="checkbox"/>

OK

Cancel

Delete User

3.10 System Maintenance

For the system setup, there are several items that you have to know the way of configuration: Status, TR-069, User Password, Configuration Backup, Syslog/Mail Alert, Time and Date, Management, Reboot System and Firmware Upgrade.

Below shows the menu items for System Maintenance.

- ▶ **System Maintenance**
 - System Status
 - TR-069
 - User Password
 - Configuration Backup
 - Syslog / Mail Alert
 - Time and Date
 - Management
 - Reboot System
 - Firmware Upgrade

3.10.1 System Status

The **System Status** provides basic network settings of Vigor router. It includes LAN and WAN interface information. Also, you could get the current running firmware version or firmware related information from this presentation.

System Status

Auto-refresh

Model : Vigor2130n
Firmware Version : v1.3.0
Build Date/Time : Thu Apr 1 15:50:22 CST 2010
System Date : Thu Apr 15 06:35:17 2010
System Uptime : 0d 23:34:41

System	
CPU Usage	: 0%
Memory Usage	: 24076K / 62796K (38.34%)

LAN	
MAC Address	: 00:50:00:00:00:01
IP Address	: 192.168.1.1
IP Mask	: 255.255.255.0
IPv6 Address	: 2000::1/64 (Global)
IPv6 Address	: fe80::200:ff:fe00:0/64 (Link)
DHCP Server	: Yes

WAN	
Connection Mode	: Static
Link Status	: Connected
MAC Address	: 00:50:00:00:00:02
IP Address	: 172.16.3.102
IP Mask	: 255.255.0.0
IPv6 Address	: fe80::250:ff:fe00:2/64 (Link)
Default Gateway	: 172.16.1.1
Primary DNS	: 168.95.1.1
Secondary DNS	:

Model Name	Display the model name of the router.
Firmware Version	Display the firmware version of the router.
Build Date/Time	Display the date and time of the current firmware build.
System Date	Display current time and date for the system server.
System Uptime	Display the connection time for the system server.
<i>System-----</i>	
CPU Usage	Display the percentage of the CPU usage of your system.
Memory Usage	Display the size of the memory usage and the percentage.
<i>LAN-----</i>	
MAC Address	Display the MAC address of the LAN Interface.
IP Address	Display the IP address of the LAN interface.
IP Mask	Display the subnet mask address of the LAN interface.
IPv6 Address (Global)	Display the global IPv6 address of the LAN interface.
IPv6 Address (Link)	Display the link local IPv6 address of the LAN interface.
DHCP Server	Display if the DHCP server is active or not.
<i>WAN-----</i>	
Connection Mode	Display current connection type used.
Link Status	Display the connection status.
MAC Address	Display the MAC address of the WAN Interface.
IP Address	Display the IP address of the WAN interface.
IP Mask	Display the subnet mask address of the WAN interface.
IPv6 Address (Link)	Display the IPv6 address of the WAN interface.
Default Gateway	Display the gateway address of the WAN interface.
Primary DNS	Display the specified primary DNS setting.
Secondary DNS	Display the specified secondary DNS setting.
<i>Wireless LAN-----</i>	

MAC Address	Display the MAC address of the wireless LAN.
Device Type	Display the device type used for wireless LAN.
SSID	Display the SSID of the router.
Channel	Display the channel that wireless LAN used.
Manufacturer	Display the manufacturer of the disk.
Model	Display the model of the disk.
Size	Display the storage size of the USB diskette.
Status	Display current status of the USB diskette.

3.10.2 TR069

Vigor router with TR-069 is available for matching with VigorACS server. Such page provides VigorACS and CPE settings under TR-069 protocol. All the settings configured here is for CPE to be controlled and managed with VigorACS server. Users need to type URL, username and password for the VigorACS server that such device will be connected. However URL, username and password under CPE client are fixed that users cannot change it. The default CPE username and password are "vigor" and "password". You will need it when you configure VigorACS server.

[System Maintenance >> TR-069 Setting](#)

ACS Settings

URL	<input type="text"/>
Username	<input type="text"/>
Password	<input type="password"/>

CPE Settings

Enable	<input type="checkbox"/>
URL	<input type="text" value="http://172.16.3.102:8069/cwm/CRN.html"/>
Port	<input type="text" value="8069"/>
Username	<input type="text" value="vigor"/>
Password	<input type="password" value="password"/>

Periodic Inform Settings

Enable	<input checked="" type="checkbox"/>
Interval Time	<input type="text" value="300"/> second(s)

ACS Settings

Such data must be typed according to the ACS (Auto Configuration Server) you want to link. Please refer to VigorACS user's manual for detailed information.

URL - Type the URL for VigorACS server.

If the connected CPE needs to be authenticated, please set URL as the following and type username and password for VigorACS server:

http://{IP address of VigorACS}:8080/ACSServer/services/ACSServlet

If the connected CPE does not need to be authenticated

please set URL as the following:

*http://{IP address of
VigorACS}:8080/ACSserver/services/UnAuthACSServ
let*

Username/Password - Type username and password for ACS Server for authentication. For example, if you want to use such CPE with VigorACS, you can type as the following:

Username: *acs*

Password: *password*

CPE Settings

Such information is useful for Auto Configuration Server.

Enable/Disable – Allow/Deny the CPE Client to connect with Auto Configuration Server.

Port – Sometimes, port conflict might be occurred. To solve such problem, you might change port number for CPE.

Periodic Inform Settings

Disable – The system will not send inform message to ACS server.

Enable – The system will send inform message to ACS server periodically (with the time set in the box of interval time).

The default setting is **Enable**. Please set interval time or schedule time for the router to send notification to CPE. Or click **Disable** to close the mechanism of notification.

3.10.3 User Password

This page allows you to set new password for user operation.

[System Maintenance >> User Password](#)

User Password

Old Password	<input type="text"/>
New Password	<input type="text"/>
Confirm New Password	<input type="text"/>

OK

Old Password

Type in the old password. The factory default setting for password is blank.

New Password

Type in new password in this field.

Confirm New Password

Type in the new password again.

When you click **OK**, the login window will appear. Please use the new password to access into the web configurator again.

3.10.4 Configuration Backup

Backup the Configuration

Follow the steps below to backup your configuration.

1. Go to **System Maintenance >> Configuration Backup**. The following windows will be popped-up, as shown below.

System Maintenance >> Configuration Backup

Configuration Backup / Restoration

Backup

Please specify a key and click Backup to download current running configurations as a encrypted file.

Key (optional):

Note: You will need the same key to do configuration restoration.

Restoration

Select a configuration file.

Please enter the key and click Restore to upload the configuration file.

key (optional):

2. Type a key arbitrarily for encrypting the file. Keep the key in mind. You will need it whenever you want to restore such file. Click **Backup** button to get into the following dialog. Click **Save** button to open another dialog for saving configuration as a file.

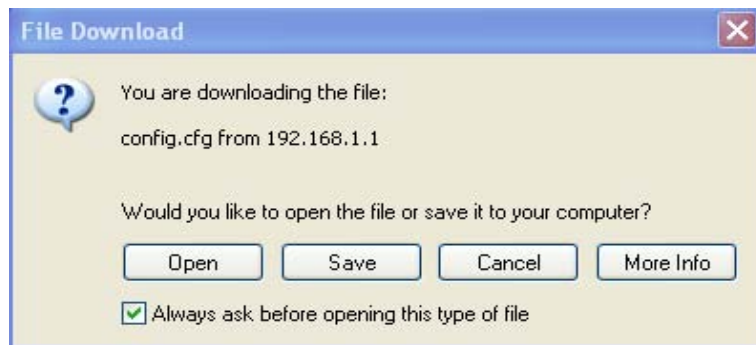

3. In **Save As** dialog, the default filename is **config.cfg**. You could give it another name by yourself.

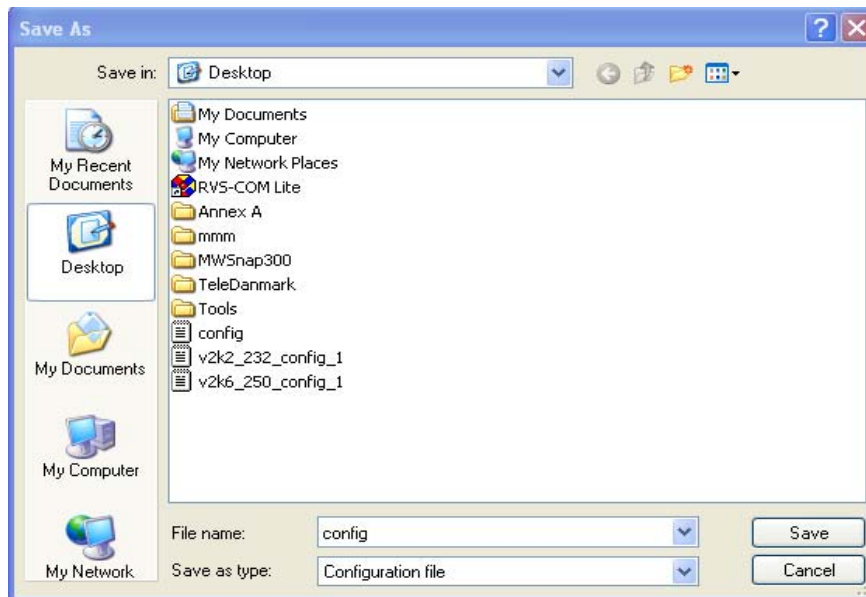

4. Click **Save** button, the configuration will download automatically to your computer as a file named **config.cfg**.

The above example is using **Windows** platform for demonstrating examples. The **Mac** or **Linux** platform will appear different windows, but the backup function is still available.

Note: Backup for Certification must be done independently. The Configuration Backup does not include information of Certificate.

Restore Configuration

1. Go to **System Maintenance >> Configuration Backup**. The following windows will be popped-up, as shown below.

System Maintenance >> Configuration Backup

Configuration Backup / Restoration

Backup

Please specify a key and click Backup to download current running configurations as a encrypted file.

Key (optional):

Note: You will need the same key to do configuration restoration.

Restoration

Select a configuration file.

Please enter the key and click Restore to upload the configuration file.

key (optional):

2. Click **Browse** button to choose the correct configuration file for uploading to the router. Click **Restore** button and wait for few seconds, the following picture will tell you that the restoration procedure is successful.

Note: If the file you want to restore has been encrypted, you will be asked to type the encrypted key before clicking **Restore**.

3.10.5 Syslog / Mail Alert

SysLog function is provided for users to monitor router. There is no bother to directly get into the Web Configurator of the router or borrow debug equipments.

System Maintenance >> Syslog / Mail Alert Setup

Syslog Access Setup

Enable	<input type="checkbox"/>
Router Name	Vigor2130
Server IP Address	
Destination Port	514
Log Level	All

Mail Alert Setup

Enable	<input type="checkbox"/>
SMTP Server	
Mail To	
Mail From	
User Name	
Password	
Enable E-Mail Alert:	
<input checked="" type="checkbox"/> User Login	

OK Cancel

Enable (Syslog Access...)

Check the box to activate function of syslog.

Router Name

Type a name of this device.

Server IP Address

The IP address of the Syslog server.

Destination Port

Type a port for the Syslog protocol.

Log Level

Choose the severity level for the system log entry.

All	▼
All	
Info	
Warning	
Error	

Enable (Mail Alert...)

Check the box to activate function of mail alert.

Send a test e-mail

Make a simple test for the e-mail address specified in this page. Please assign the mail address first and click this button to execute a test for verify the mail address is available or not.

SMTP Server

The IP address of the SMTP server.

Mail To

Assign a mail address for sending mails out.

Mail From

Assign a path for receiving the mail from outside.

User Name

Type the user name for authentication.

Password

Type the password for authentication.

Enable E-mail Alert

Check the box of User Login to send alert message to the e-mail box while the router detecting the item(s) you specify here.

Click **OK** to save these settings.

For viewing the Syslog, please do the following:

1. Just set your monitor PC's IP address in the field of Server IP Address
2. Install the Router Tools in the **Utility** within provided CD. After installation, click on the **Router Tools>>Syslog** from program menu.

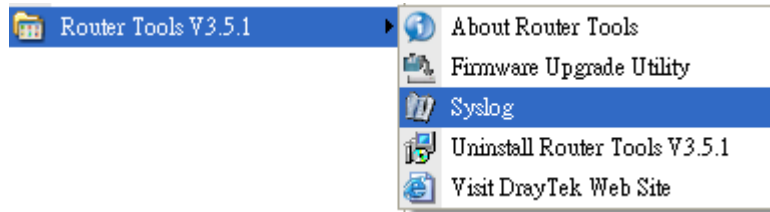

3. From the Syslog screen, select the router you want to monitor. Be reminded that in **Network Information**, select the network adapter used to connect to the router. Otherwise, you won't succeed in retrieving information from the router.

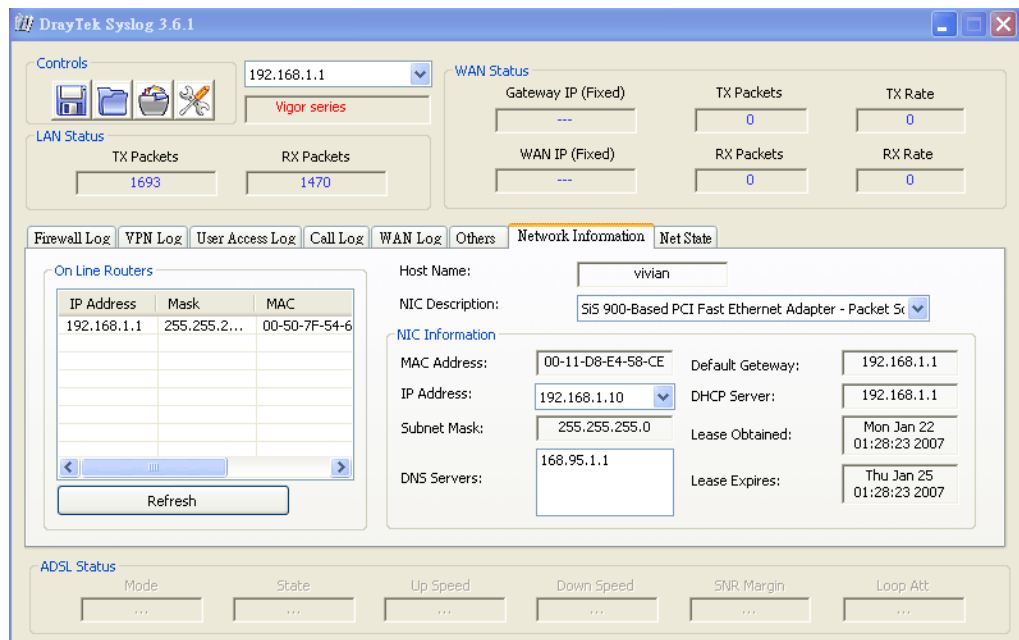

3.10.6 Time and Date

It allows you to specify where the time of the router should be inquired from.

System Maintenance >> Time and Date

Time Information

Current System Time	<input type="text" value="Tue Oct 27 03:41:37 UTC 2009"/>	<input type="button" value="Inquire Time"/>
---------------------	---	---

Time Configuration

Time Zone	
<input type="text" value="Unknown"/>	
NTP Servers	
<input type="button" value="Delete"/>	<input type="text" value="pool.ntp.org"/>
<input type="button" value="Delete"/>	<input type="text" value="time.windows.com"/>
<input type="button" value="Delete"/>	<input type="text" value="time.nist.gov"/>
<input type="button" value="Delete"/>	<input type="text" value="time.stdtime.gov.tw"/>
<input type="button" value="Add NTP server"/>	

<input type="button" value="OK"/>	<input type="button" value="Cancel"/>
-----------------------------------	---------------------------------------

Current System Time

Click **Inquire Time** to get the current time.

Time Zone

Select the time zone where the router is located.

Add NTP server

Click the button to add a new NTP server.

Delete

Click this button to remove an NTP server.

Click **OK** to save these settings.

3.10.7 Management

This page allows you to manage the settings for access control, access list, port setup, and SMP setup. For example, as to management access control, the port number is used to send/receive SIP message for building a session. The default value is 5060 and this must match with the peer Registrar when making VoIP calls.

System Maintenance >> Remote Management

Management Access Control

Allow management from the Internet		SNMP Setup	
Enable HTTP	<input type="checkbox"/> 80	Enable SNMP	<input type="checkbox"/> 161
Enable HTTPS	<input type="checkbox"/> 443	Manager Host IP	<input type="text"/>
Enable SSH	<input type="checkbox"/> 22		
Enable ICMP Ping	<input type="checkbox"/>		
Enable FTP	<input type="checkbox"/> 21		
Enable TELNET	<input type="checkbox"/> 23		

Access List		
List	IP	Subnet Mask
1	<input type="text"/>	255.255.255.255 / 32
2	<input type="text"/>	255.255.255.255 / 32
3	<input type="text"/>	255.255.255.255 / 32

OK

Enable HTTP/HTTPS/SSH/ICMP Ping/FTP/TELNET

Enable the checkbox to allow system administrators to login from the Internet. There are several servers provided by the system to allow you managing the router from Internet. Check the box(es) to specify.

Enable SNMP

Check it to enable such service.

Manager Host IP – Set one host as the manager to execute SNMP function. Type the IP address to specify the certain host.

Access List

You could specify that the system administrator can only login from a specific host or network defined in the list. A maximum of three IPs/subnet masks is allowed.

List IP - Indicate an IP address allowed to login to the router.

Subnet Mask - Represent a subnet mask allowed to login to the router.

3.10.8 Reboot System

The Web Configurator may be used to restart your router for using current configuration. Click **Reboot System** from **System Maintenance** to open the following page.

System Maintenance >> Reboot System

Reboot System

Do You want to reboot your router ?

Using current configuration
 Using factory default configuration

Click **OK**. The router will take 5 seconds to reboot the system.

Note: When the system pops up Reboot System web page after you configure web settings, please click **OK** to reboot your router for ensuring normal operation and preventing unexpected errors of the router in the future.

3.10.9 Firmware Upgrade

Before upgrading your router firmware, you need to install the Router Tools. The **Firmware Upgrade Utility** is included in the tools. The following web page will guide you to upgrade firmware by using an example. Note that this example is running over Windows OS (Operating System).

Download the newest firmware from DrayTek's web site or FTP site. The DrayTek web site is www.draytek.com (or local DrayTek's web site) and FTP site is [ftp.draytek.com](ftp://draytek.com).

Click **Maintenance>> Firmware Upgrade** to launch the Firmware Upgrade Utility.

System Maintenance >> Firmware Upgrade

Firmware Upgrade

Current Firmware Version: v1.3.0

Select a firmware file.

Click Upgrade to upload the file.

Note: It is strongly recommended that you do a configuration backup before upgrading.

Click **Browse..** to locate the newest firmware and click **Upgrade**. During the process of upgrade, do not turn off your router.

4

Admin Mode Operation

This chapter will guide users to execute advanced (full) configuration through admin mode operation.

1. Open a web browser on your PC and type **http://192.168.1.1**. The window will ask for typing username and password.
2. Please type “**admin/admin**” on Username/Password for administration operation.

Now, the **Main Screen** will appear. Be aware that “Admin mode” will be displayed on the bottom left side.

The screenshot displays the DrayTek Vigor2130 Series High Speed Gigabit Router Admin Mode Main Screen. The interface is divided into several sections:

- System Status:** Model: Vigor2130n, Firmware Version: v1.3.0.1, Build Date/Time: Wed Apr 14 15:28:51 CST 2010, System Date: Mon Apr 26 05:33:52 2010, System Uptime: 0d 02:17:01.
- System:** CPU Usage: 0%, Memory Usage: 22676K / 62796K (36.11%).
- LAN:** MAC Address: 00:50:7F:C8:6A:FC, IP Address: 192.168.1.1, IP Mask: 255.255.255.0, IPv6 Address: 2000::1/64 (Global), IPv6 Address: fe80::200:ff:fe00:0/64 (Link), DHCP Server: Yes.
- Wireless:** MAC Address: 00:50:7F:C8:6A:FC, SSID: DrayTek, Channel: 11.
- WAN:** Connection Mode: Static, Link Status: Connected, MAC Address: 00:50:7F:C8:6A:FD, IP Address: 172.16.3.102, IP Mask: 255.255.0.0, IPv6 Address: fe80::250:7fff:fec8:6afd/64 (Link), Default Gateway: 172.16.1.1, Primary DNS: 168.95.1.1, Secondary DNS: .

The interface also includes a navigation menu on the left with options like Quick Start Wizard, Online Status, WAN, LAN, NAT, Firewall, Bandwidth Management, Applications, VPN and Remote Access, Wireless LAN, USB Application, IPv6, User, System Maintenance, and Diagnostics. A Logout button and 'Admin mode' indicator are visible at the bottom.

4.1 WAN

Quick Start Wizard offers user an easy method to quick setup the connection mode for the router. Moreover, if you want to adjust more settings for different WAN modes, please go to **Internet Access** group.

Basics of Internet Protocol (IP) Network

IP means Internet Protocol. Every device in an IP-based Network including routers, print server, and host PCs, needs an IP address to identify its location on the network. To avoid address conflicts, IP addresses are publicly registered with the Network Information Centre (NIC). Having a unique IP address is mandatory for those devices participated in the public network but not in the private TCP/IP local area networks (LANs), such as host PCs under the management of a router since they do not need to be accessed by the public. Hence, the NIC has reserved certain addresses that will never be registered publicly. These are known as *private* IP addresses, and are listed in the following ranges:

From 10.0.0.0 to 10.255.255.255

From 172.16.0.0 to 172.31.255.255

From 192.168.0.0 to 192.168.255.255

What are Public IP Address and Private IP Address

As the router plays a role to manage and further protect its LAN, it interconnects groups of host PCs. Each of them has a private IP address assigned by the built-in DHCP server of the Vigor router. The router itself will also use the default **private IP** address: 192.168.1.1 to communicate with the local hosts. Meanwhile, Vigor router will communicate with other network devices through a **public IP** address. When the data flow passing through, the Network Address Translation (NAT) function of the router will dedicate to translate public/private addresses, and the packets will be delivered to the correct host PC in the local area network. Thus, all the host PCs can share a common Internet connection.

Get Your Public IP Address from ISP

In ADSL deployment, the PPP (Point to Point)-style authentication and authorization is required for bridging customer premises equipment (CPE). Point to Point Protocol over Ethernet (PPPoE) connects a network of hosts via an access device to a remote access concentrator or aggregation concentrator. This implementation provides users with significant ease of use. Meanwhile it provides access control, billing, and type of service according to user requirement.

When a router begins to connect to your ISP, a serial of discovery process will occur to ask for a connection. Then a session will be created. Your user ID and password is authenticated via **PAP** or **CHAP** with **RADIUS** authentication system. And your IP address, DNS server, and other related information will usually be assigned by your ISP.

Network Connection by 3G USB Modem

For 3G mobile communication through Access Point is popular more and more, Vigor router adds the function of 3G network connection for such purpose. By connecting 3G USB Modem to the USB port of Vigor router, it can support HSDPA/UMTS/EDGE/GPRS/GSM and the future 3G standard (HSUPA, etc). Vigor router with 3G USB Modem allows you to receive 3G signals at any place such as your car or certain location holding outdoor activity and share the bandwidth for using by more people. Users can use four LAN ports on the router to access Internet. Also, they can access Internet via SuperG wireless function of Vigor router, and enjoy the powerful firewall, bandwidth management, VPN, VoIP features of Vigor router.



After connecting into the router, 3G USB Modem will be regarded as the second WAN port. However, the original Ethernet WAN still can be used and Load-Balance can be done in the router. Besides, 3G USB Modem also can be used as backup device. Therefore, when WAN is not available, the router will use 3.5G for supporting automatically. The supported 3G USB Modem will be listed on DrayTek web site. Please visit www.draytek.com for more detailed information.

Below shows the menu items for WAN.



4.1.1 Internet Access

This page allows you to set WAN configuration with different modes. Use the Connection Type drop down list to choose one of the WAN modes. The corresponding page will be displayed.

WAN >> Internet Access

WAN IP Configuration

Connection Type	DHCP	▼
-----------------	------	---

DHCP Settings

Router Name	Vigor2130	(The same as syslog's router name)
-------------	-----------	--------------------------------------

WAN Connection Detection

Mode	ARP	▼
Ping IP	0.0.0.0	

Clone MAC Address

Enable	<input type="checkbox"/>
--------	--------------------------

Static

For static IP mode, you usually receive a fixed public IP address or a public subnet, namely multiple public IP addresses from your DSL or Cable ISP service providers. In most cases, a Cable service provider will offer a fixed public IP, while a DSL service provider will offer a public subnet. If you have a public subnet, you could assign an IP address or many IP address to the WAN interface.

To use **Static** as the accessing protocol of the internet, please choose **Static** mode from **Connection Type** drop down menu. The following web page will be shown.

WAN >> Internet Access

WAN IP Configuration

Connection Type	Static IP
-----------------	-----------

Static IP Settings

IP Address	172.16.3.102
Subnet Mask	255.255.0.0
Gateway IP Address	172.16.1.1
Primary DNS Server	168.95.1.1
Secondary DNS Server	0.0.0.0

WAN Connection Detection

Mode	ARP
Ping IP	0.0.0.0

Clone MAC Address

Enable	<input type="checkbox"/>
--------	--------------------------

OK

IP Address	Type the IP address.
Subnet Mask	Type the subnet mask.
Gateway IP Address	Type the gateway IP address.
Primary DNS Server	You must specify a DNS server IP address here because your ISP should provide you with usually more than one DNS Server. If your ISP does not provide it, the router will automatically apply default DNS Server IP address: 198.95.1.1 to this field.
Secondary DNS Server	You can specify secondary DNS server IP address here because your ISP often provides you more than one DNS Server. If your ISP does not provide it, the router will automatically apply default secondary DNS Server IP address: 4.2.2.1 to this field.
Mode	Such function allows you to verify whether network connection is alive or not through ARP Detect or Ping Detect. Choose ARP Detect or Ping Detect for the system to execute for WAN detection.
Ping IP	If you choose Ping Detect as detection mode, you have to type IP address in this field for pinging.
Clone MAC Address	It is available when the box of Enable is checked. Click Clone MAC Address . The result will be displayed in the field of MAC Address.

Enable



Clone MAC Address

MAC Address

00-0E-A6-2A-D5-A1

After finishing all the settings here, please click **OK** to activate them.

DHCP

DHCP allows a user to obtain an IP address automatically from a DHCP server on the Internet. If you choose **DHCP** mode, the DHCP server of your ISP will assign a dynamic IP address for your router automatically. It is not necessary for you to assign any setting,

WAN >> Internet Access

WAN IP Configuration

Connection Type	DHCP
-----------------	------

DHCP Settings

Router Name	Vigor2130	(The same as syslog's router name)
-------------	-----------	--------------------------------------

WAN Connection Detection

Mode	ARP
Ping IP	0.0.0.0

Clone MAC Address

Enable	<input type="checkbox"/>
--------	--------------------------

OK

Router Name

Type in a name for the router. It must be the same as the name used in Syslog.

Mode

Such function allows you to verify whether network connection is alive or not through ARP Detect or Ping Detect. Choose **ARP Detect** or **Ping Detect** for the system to execute for WAN detection.

Ping IP

If you choose **Ping Detect** as detection mode, you have to type IP address in this field for pinging.

Clone MAC Address

It is available when the box of Enable is checked. Click **Clone MAC Address**. The result will be displayed in the field of MAC Address.

Enable



Clone MAC Address

MAC Address

00-0E-A6-2A-D5-A1

After finishing all the settings here, please click **OK** to activate them.

PPPoE

To choose PPPoE as the accessing protocol of the internet, please select **PPPoE** from the **Internet Access** menu. The following web page will be shown.

WAN >> Internet Access

WAN IP Configuration

Connection Type	PPPoE
-----------------	-------

PPPoE Settings

Username	<input type="text"/>
Password	<input type="password"/>
Redial Policy	Connect on Demand
Idle Time out	<input type="text"/>
MTU Size	<input type="text"/>

WAN Connection Detection

Mode	Ping Detect
Ping IP	0.0.0.0

Clone MAC Address

Enable	<input type="checkbox"/>
--------	--------------------------

OK

- Username** Type in the username provided by ISP in this field.
- Password** Type in the password provided by ISP in this field.
- Redial Policy** If you want to connect to Internet all the time, you can choose **Always On**. Otherwise, choose **Connect on Demand**.
- | |
|-------------------|
| Connect on Demand |
| Connect on Demand |
| Always On |
- Idle Time Out** Set the timeout for breaking down the Internet after passing through the time without any action. When you choose **Connect on Demand**, you have to type value here.
- MTU Size** It means Max Transmit Unit for packet. The default setting is 1442.
- Mode** Such function allows you to verify whether network connection is alive or not through ARP Detect or Ping Detect. Choose **ARP Detect** or **Ping Detect** for the system to execute for WAN detection.
- Ping IP** If you choose **Ping Detect** as detection mode, you have to type IP address in this field for pinging.
- Enable/Disable** Click **Enable** for activating this function. If you click **Disable**, this function will be closed and all the settings that you adjusted in this page will be invalid.
- Clone MAC Address** It is available when the box of Enable is checked. Click **Clone MAC Address**. The result will be displayed in the field of MAC Address.

Enable



Clone MAC Address

MAC Address

00-0E-A6-2A-D5-A1

After finishing all the settings here, please click **OK** to activate them.

PPTP/L2TP

To use **PPTP/L2TP** as the accessing protocol of the internet, please choose **PPTP/L2TP** from **Connection Type** drop down menu. The following web page will be shown.

WAN >> Internet Access

WAN IP Configuration

Connection Type	PPTP
PPTP Settings	
Username	<input type="text"/>
Password	<input type="text"/>
Server Address	0.0.0.0
WAN IP Network Settings	Static IP
IP Address	0.0.0.0
Subnet Mask	0.0.0.0
Primary DNS Server	0.0.0.0
Secondary DNS Server	0.0.0.0
Redial Policy	Connect on Demand
Idle Time out	<input type="text"/>
MTU Size	<input type="text"/>
Clone MAC Address	
Enable	<input type="checkbox"/>

OK

Cancel

- Username** Type in the username provided by ISP in this field.
- Password** Type in the password provided by ISP in this field.
- Server Address** Type in the IP address for PPTP /L2TP server.
- WAN IP Network Settings** You can choose Static IP or DHCP as WAN IP network setting.
- IP Address** Type the IP address if you choose Static IP as the WAN IP network setting.
- Subnet Mask** Type the subnet mask if you chose Static IP as the WAN IP.
- Primary DNS Server** You must specify a DNS server IP address here because your ISP should provide you with usually more than one DNS Server. If your ISP does not provide it, the router will automatically apply default DNS Server IP address: 194.109.6.66 to this field.
- Secondary DNS Server** You can specify secondary DNS server IP address here because your ISP often provides you more than one DNS Server. If your ISP does not provide it, the router will automatically apply default secondary DNS Server IP address: 194.98.0.1 to this field.

Redial Policy

If you want to connect to Internet all the time, you can choose **Always On**. Otherwise, choose **Connect on Demand** and

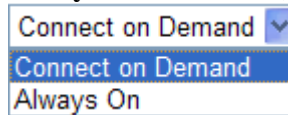

Connect on Demand ▼
Connect on Demand
Always On

Idle Time Out

Set the timeout for breaking down the Internet after passing through the time without any action. When you choose **Connect on Demand**, you have to type value here.

MTU Size

It means Max Transmit Unit for packet. The default setting is 1442.

Clone MAC Address

It is available when the box of Enable is checked. Click **Clone MAC Address**. The result will be displayed in the field of MAC Address.



Enable Clone MAC Address
MAC Address 00-0E-A6-2A-D5-A1

After finishing all the settings here, please click **OK** to activate them.

3G USB Modem

If your router connects to a 3G modem and you want to access Internet via 3G modem, choose 3G as connection type and type the required information in this web page.

WAN >> Internet Access

WAN IP Configuration

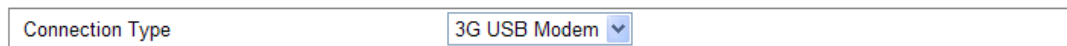

Connection Type 3G USB Modem ▼

3G USB Modem Settings

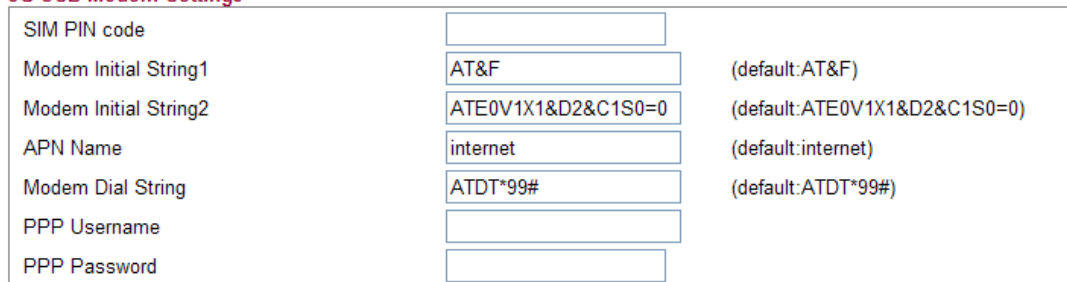

SIM PIN code	<input type="text"/>	
Modem Initial String1	AT&F	(default:AT&F)
Modem Initial String2	ATE0V1X1&D2&C1S0=0	(default:ATE0V1X1&D2&C1S0=0)
APN Name	internet	(default:internet)
Modem Dial String	ATDT*99#	(default:ATDT*99#)
PPP Username	<input type="text"/>	
PPP Password	<input type="text"/>	

Clone MAC Address



Enable



OK Cancel

SIM PIN code

Type PIN code of the SIM card that will be used to access Internet.

Modem Initial String1/2

Such value is used to initialize USB modem. Please use the default value. If you have any question, please contact to your ISP.

APN Name

APN means Access Point Name which is provided and required by some ISPs.

- Modem Dial String** Such value is used to dial through USB mode. Please use the default value. If you have any question, please contact to your ISP.
- PPP Username** Type the PPP username (optional).
- PPP Password** Type the PPP password (optional).
- Clone MAC Address** It is available when the box of Enable is checked. Click **Clone MAC Address**. The result will be displayed in the field of MAC Address.

Enable Clone MAC Address

MAC Address



After finishing all the settings here, please click **OK** to activate them.

4.1.2 Ports

Ports page is used to change the setting for WAN port. You can set or reset the following items. All of them are described in detail below.

WAN >> Ports

Port Configuration

Port	Link	Speed		Flow Control			Maximum Frame	Excessive Collision Mode	Power Control
		Current	Configured	Current Rx	Current Tx	Configured			
WAN		100fdx	Auto			<input type="checkbox"/>	151B	Discard	Enabled

- Port** It displays current network interface.
- Link** It displays current connection status. Green light means the WAN connection is successful.
- Current** It displays current speed that the router uses.
- Speed Configured** You can use the drop down list to choose the required speed for the router. If you have no idea in configuring speed, simple use the default setting, **Auto**.

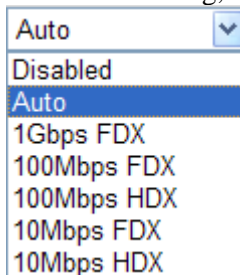

- Flow Control** If flow control is enabled by checking **Configured** box, both parties can send PAUSE frame to the transmitting device(s) if the receiving port is too busy to handle. If not, there will be no flow control in the port. It drops the packet if too much to handle.
Current Rx: indicates whether pause frames on the port are obeyed.

Current Tx: indicates whether pause frames on the port are transmitted.

Maximum Frame

This module offers 1518~9600 (Bytes) length to make the long packet for data transmission.

Excessive Collision Mode

There are two modes for you to choose when excessive collision happened in half-duplex condition.

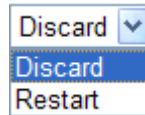

Discard - It determines whether the MAC drops frames after an excessive collision has occurred. If yes, a frame is dropped after excessive collision. This is IEEE Standard 802.3 half-duplex flow control operation.

Restart - It determines whether the MAC retransmits frames after an excessive collision has occurred. If set, a frame is not dropped after excessive collisions, but the backoff sequence is restarted. This is a violation of IEEE Standard 802.3, but is useful in non-dropping half-duplex flow control operation.

Power Control

The Configured column allows for changing the power savings mode parameters per port.

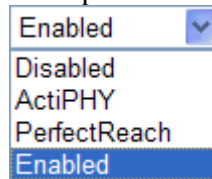

Disabled: All power savings mechanisms disabled.

ActiPHY: Link down power savings enabled.

PerfectReach: Link up power savings enabled.

Enabled: Both link up and link down power savings enabled.

Refresh

Click this button to refresh the information for WAN port.

After finishing all the settings here, please click **OK** to activate them.

4.1.3 3G Backup

This page is used to setup 3G backup function. If you enable 3G backup, make sure your WAN connection type is not in 3G mode. When the WAN connection is broken, router will try to keep the connection with 3G mode. After WAN connection is recovered, router will disconnect the 3G connection automatically.

WAN >> 3G backup

3G Backup Configuration

<input type="checkbox"/> Enable 3G Backup		
SIM PIN code	<input type="text"/>	
Modem Initial String1	<input type="text" value="AT&F"/>	(default:AT&F)
Modem Initial String2	<input type="text" value="ATE0V1X1&D2&C1S0=0"/>	(default:ATE0V1X1&D2&C1S0=0)
APN Name	<input type="text" value="internet"/>	(default:internet)
Modem Dial String	<input type="text" value="ATDT*99#"/>	(default:ATDT*99#)
PPP Username	<input type="text"/>	
PPP Password	<input type="text"/>	

OK Cancel

SIM PIN code

Type PIN code of the SIM card that will be used to access Internet.

Modem Initial String1/2

Such value is used to initialize USB modem. Please use the default value. If you have any question, please contact to your ISP.

APN Name

APN means Access Point Name which is provided and required by some ISPs.

Modem Dial String

Such value is used to dial through USB mode. Please use the default value. If you have any question, please contact to your ISP.

PPP Username

Type the PPP username (optional).

PPP Password

Type the PPP password (optional).

Clone MAC Address

It is available when the box of Enable is checked. Click **Clone MAC Address**. The result will be displayed in the field of MAC Address.

Enable	<input checked="" type="checkbox"/>	<input type="button" value="Clone MAC Address"/>
MAC Address		<input type="text" value="00-0E-A6-2A-D5-A1"/>

4.2 LAN

Local Area Network (LAN) is a group of subnets regulated and ruled by router. The design of network structure is related to what type of public IP addresses coming from your ISP.

- ▶ LAN
 - General Setup
 - Ports
 - MAC Address Table
 - VLAN
 - Monitor Port
 - Static Route
 - Bind IP to MAC

Basics of LAN

The most generic function of Vigor router is NAT. It creates a private subnet of your own. As mentioned previously, the router will talk to other public hosts on the Internet by using public IP address and talking to local hosts by using its private IP address. What NAT does is to translate the packets from public IP address to private IP address to forward the right packets to the right host and vice versa. Besides, Vigor router has a built-in DHCP server that assigns private IP address to each local host. See the following diagram for a briefly understanding.

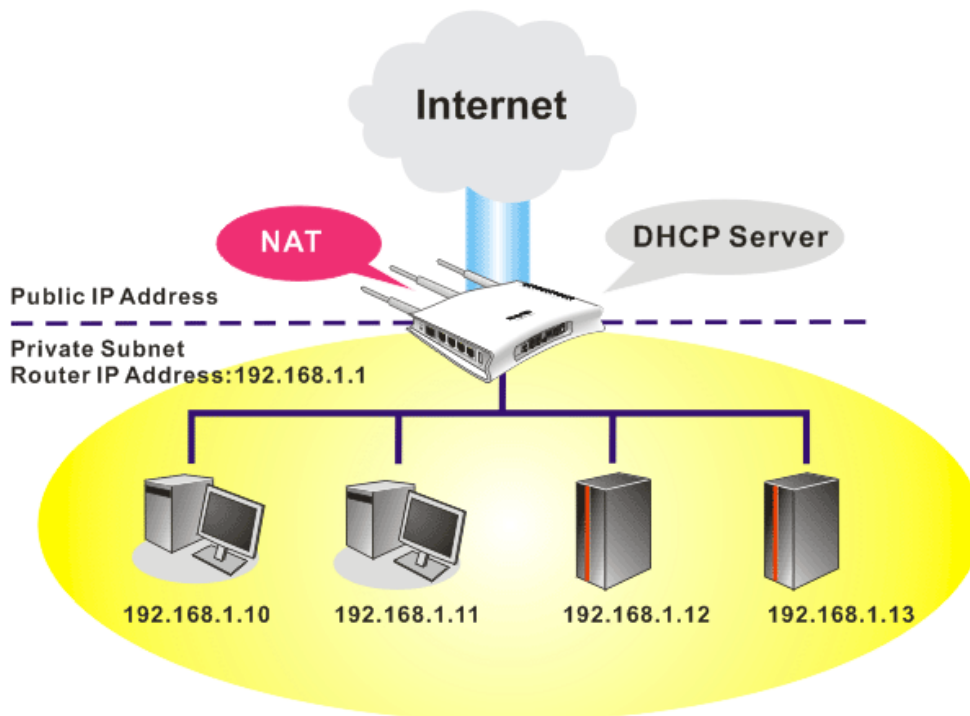

In some special case, you may have a public IP subnet from your ISP such as 220.135.240.0/24. This means that you can set up a public subnet or call second subnet that each host is equipped with a public IP address. As a part of the public subnet, the Vigor router will serve for IP routing to help hosts in the public subnet to communicate with other public hosts or servers outside. Therefore, the router should be set as the gateway for public hosts.

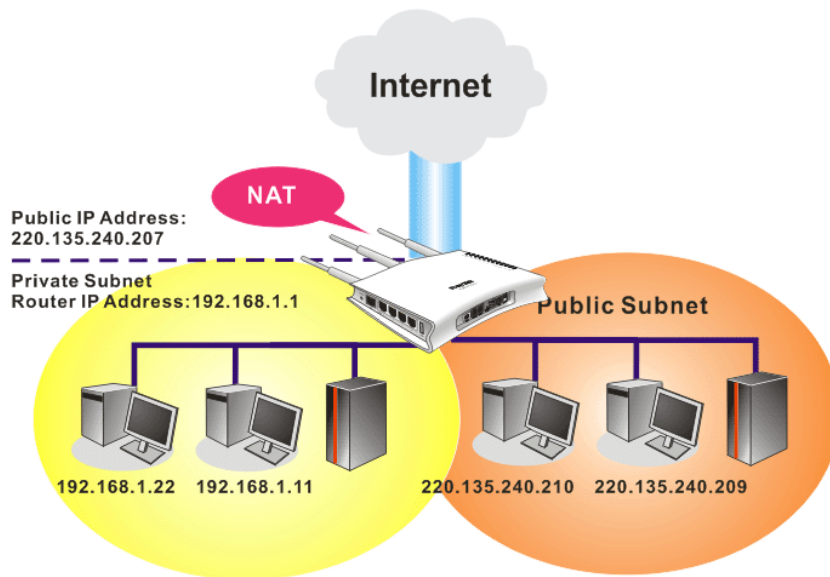

What is Routing Information Protocol (RIP)

Vigor router will exchange routing information with neighboring routers using the RIP to accomplish IP routing. This allows users to change the information of the router such as IP address and the routers will automatically inform for each other.

What is Static Route

When you have several subnets in your LAN, sometimes a more effective and quicker way for connection is the **Static routes** function rather than other method. You may simply set rules to forward data from one specified subnet to another specified subnet without the presence of RIP.

What are Virtual LANs and Rate Control

You can group local hosts by physical ports and create up to 4 virtual LANs. To manage the communication between different groups, please set up rules in Virtual LAN (VLAN) function and the rate of each.

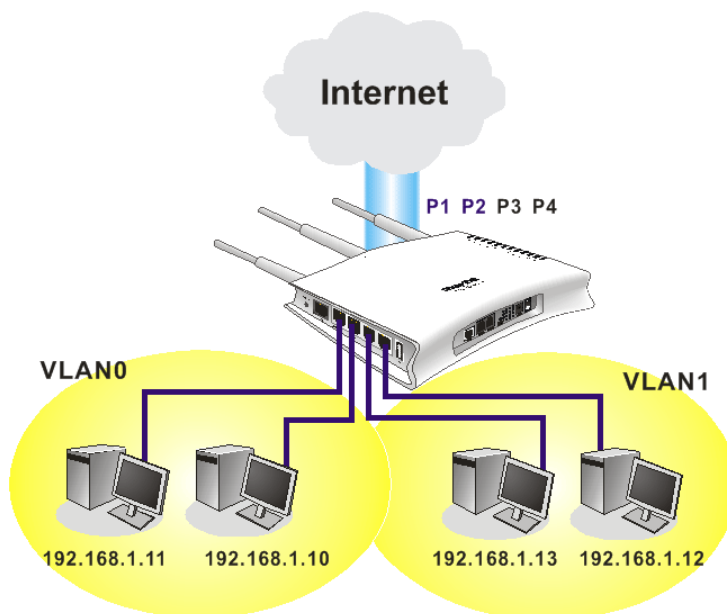

4.2.1 General Setup

This page provides you the general settings for LAN.

Click **LAN** to open the LAN settings page and choose **General Setup**.

LAN >> General Setup

LAN IP Network Configuration

IP Address	<input type="text" value="192.168.1.1"/>
Subnet Mask	<input type="text" value="255.255.255.0"/>

DHCP Server Configuration

Enable DHCP	<input checked="" type="checkbox"/>
Start IP Address	192.168.1. <input type="text" value="10"/>
IP Pool Counts	<input type="text" value="50"/>
Lease Time	<input type="text" value="720"/> minutes
Force DNS manual setting	<input type="checkbox"/>
Primary IP Address	<input type="text" value="0.0.0.0"/>
Secondary IP Address	<input type="text" value="0.0.0.0"/>

- IP Address** Type in private IP address for connecting to a local private network (Default: 192.168.1.1).
- Subnet Mask** Type in an address code that determines the size of the network. (Default: 255.255.255.0/ 24)
- Enable DHCP** DHCP stands for Dynamic Host Configuration Protocol. The router by factory default acts a DHCP server for your network so it automatically dispatch related IP settings to any local user configured as a DHCP client. It is highly recommended that you leave the router enabled as a DHCP server if you do not have a DHCP server for your network.
You can configure the router to serve as a DHCP server for the 2nd subnet. Check the box to enable DHCP server setting.
- Start IP Address** Enter a value of the IP address pool for the DHCP server to start with when issuing IP addresses. If the 2nd IP address of your router is 220.135.240.1, the starting IP address must be 220.135.240.2 or greater, but smaller than 220.135.240.254.
- IP Pool Counts** Enter the number of IP addresses in the pool. The maximum is 10. For example, if you type 3 and the 2nd IP address of your router is 220.135.240.1, the range of IP address by the DHCP server will be from 220.135.240.2 to 220.135.240.11.
- Lease Time** It allows you to set the leased time for the specified PC.
- Force DNS manual setting** Force router to use DNS servers in this page instead of DNS servers given by the Internet Access server (PPPoE, PPTP, L2TP or DHCP server).
- Primary IP Address** You must specify a DNS server IP address here because your ISP should provide you with usually more than one DNS Server. If your ISP does not provide it, the router will automatically apply default DNS Server IP address: 194.109.6.66 to this field.

Secondary IP Address

You can specify secondary DNS server IP address here because your ISP often provides you more than one DNS Server. If your ISP does not provide it, the router will automatically apply default secondary DNS Server IP address: 194.98.0.1 to this field.

The default DNS Server IP address can be found via Online Status:

If both the Primary IP and Secondary IP Address fields are left empty, the router will assign its own IP address to local users as a DNS proxy server and maintain a DNS cache.

If the IP address of a domain name is already in the DNS cache, the router will resolve the domain name immediately. Otherwise, the router forwards the DNS query packet to the external DNS server by establishing a WAN (e.g. DSL/Cable) connection.

After finishing all the settings here, please click **OK** to activate them.





4.2.2 Ports

Ports page is used to change the setting for LAN ports. You can set or reset the following items. All of them are described in detail below.

LAN >> Ports

Port Configuration

Refresh

Port	Link	Speed		Flow Control			Maximum Frame	Excessive Collision Mode	Power Control
		Current	Configured	Current Rx	Current Tx	Configured			
LAN1	 Down	Down	Auto	✗	✗	☑	1518	Discard	Enabled
LAN2	 1Gfdx	1Gfdx	Auto	☑	☑	☑	1518	Discard	Enabled
LAN3	 Down	Down	Auto	✗	✗	☑	1518	Discard	Enabled
LAN4	 Down	Down	Auto	✗	✗	☑	1518	Discard	Enabled

OK

Cancel

Port

It displays current network interface.

Link

It displays current connection status. Green light means the LAN connection is successful.

Current

It displays current speed that the router uses.

Speed Configured

It can set the speed and duplex of the port. You can use the drop down list to choose the required speed for the router. If you have no idea in configuring speed, simple use the default setting,

Auto.

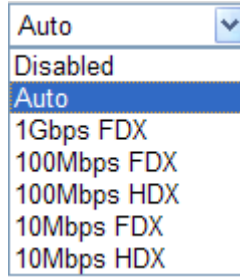

Flow Control

If flow control is enabled by checking **Configured** box, both parties can send PAUSE frame to the transmitting device(s) if the receiving port is too busy to handle. If not, there will be no flow control in the port. It drops the packet if too much to handle.

Current Rx: indicates whether pause frames on the port are obeyed.

Current Tx: indicates whether pause frames on the port are transmitted.

Maximum Frame

This module offers 1518~9600 (Bytes) length to make the long packet for data transmission.

Excessive Collision Mode

There are two modes for you to choose when excessive collision happened in half-duplex condition.

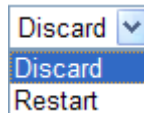

Discard - It determines whether the MAC drops frames after an excessive collision has occurred. If yes, a frame is dropped after excessive collision. This is IEEE Standard 802.3 half-duplex flow control operation.

Restart - It determines whether the MAC retransmits frames after an excessive collision has occurred. If set, a frame is not dropped after excessive collisions, but the backoff sequence is restarted. This is a violation of IEEE Standard 802.3, but is useful in non-dropping half-duplex flow control operation.

Power Control

The Configured column allows for changing the power savings mode parameters per port.

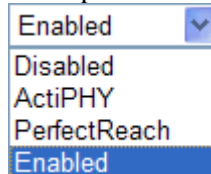

Disabled: All power savings mechanisms disabled.

ActiPHY: Link down power savings enabled.

PerfectReach: Link up power savings enabled.

Enabled: Both link up and link down power savings enabled.

Refresh

Click this button to refresh the information for LAN ports.

After finishing all the settings here, please click **OK** to activate them.

4.2.3 MAC Address Table

This page allows you to set timeouts for entries in dynamic MAC Table and configure the static MAC table here.

LAN >> MAC Address Table

MAC Address Table Configuration

Aging Configuration

Disable Automatic Aging	<input type="checkbox"/>
Age Time	<input type="text" value="300"/> seconds

MAC Table Learning

	WAN	LAN1	Port Members LAN2	LAN3	LAN4
Auto	<input checked="" type="radio"/>	<input checked="" type="radio"/>	<input checked="" type="radio"/>	<input checked="" type="radio"/>	<input checked="" type="radio"/>
Disable	<input type="radio"/>	<input type="radio"/>	<input type="radio"/>	<input type="radio"/>	<input type="radio"/>
Secure	<input type="radio"/>	<input type="radio"/>	<input type="radio"/>	<input type="radio"/>	<input type="radio"/>

Static MAC Table Configuration

Delete	VLAN ID	MAC Address	Port Members WAN	LAN1	LAN2	LAN3	LAN4
<input type="button" value="Add New Static Entry"/>							

Disable Automatic Aging

Stop the MAC table aging timer, the learned MAC address will not age out automatically. The default setting is enabled. Check the box to disable this function if required.

Age Time

Delete a MAC address idling for a period of time from the following MAC Table, which will not affect static MAC address. Range of MAC Address Aging Time is 10-1000000 seconds. The default Aging Time is 300 seconds.

MAC Table Learning

List the port members which apply dynamic learning mechanism or not.

Auto - Enable this port MAC address dynamic learning mechanism.

Disable - Disable this port MAC address dynamic learning mechanism, only support static MAC address setting.

Secure - Disable this port MAC address dynamic learning mechanism and copy the dynamic learning packets to CPU.

Static MAC Table Config..

Specify static MAC address with VLAN ID to apply aging configuration.

Delete - Click the button to remove the VLAN setting.

VLAN ID - Specify the interface for the port members.

MAC Address - It is a six-byte long Ethernet hardware address and usually expressed by hex and separated by hyphens. For example, 00 - 40 - C7 - D6 - 00 - 02.

WAN/LAN1~4 - Check the port to apply this VLAN setting.

To add a new static MAC entry, click **Add new static entry**. A new entry will be shown as follows. Choose VLAN ID and type a new MAC address. Next, specify port member for this table. Finally, click OK to save the changes.

Static MAC Table Configuration

Delete	VLAN ID	MAC Address	WAN	Port Members			
Delete	1(LAN)	00-00-00-00-00-00	<input type="checkbox"/>	LAN1	LAN2	LAN3	LAN4
<input type="checkbox"/>			<input type="checkbox"/>	<input type="checkbox"/>	<input type="checkbox"/>	<input type="checkbox"/>	<input type="checkbox"/>

Add new static entry

OK Cancel

4.2.4 VLAN

Virtual LAN function provides you a very convenient way to manage hosts by grouping them based on the physical port. You can also manage the in/out rate of each port. Go to **LAN** page and select **VLAN**. The following page will appear. VLAN function is enabled in default.

LAN >> VLAN

Private VLAN Membership Configuration

Delete	PVLAN ID	LAN1	Port Members			
<input type="checkbox"/>	1	<input checked="" type="checkbox"/>	LAN2	LAN3	LAN4	
<input checked="" type="checkbox"/>		<input checked="" type="checkbox"/>	<input checked="" type="checkbox"/>	<input checked="" type="checkbox"/>	<input checked="" type="checkbox"/>	

Add New Private VLAN

OK Cancel

Add New Private VLAN

Click this button to add a new private VLAN. The router allows you to add up to 4 VLAN.

LAN >> VLAN

Private VLAN Membership Configuration

Delete	PVLAN ID	LAN1	Port Members			
<input type="checkbox"/>	1	<input checked="" type="checkbox"/>	LAN2	LAN3	LAN4	
<input type="checkbox"/>		<input checked="" type="checkbox"/>	<input checked="" type="checkbox"/>	<input checked="" type="checkbox"/>	<input checked="" type="checkbox"/>	
<input type="checkbox"/>	0	<input type="checkbox"/>	<input type="checkbox"/>	<input type="checkbox"/>	<input type="checkbox"/>	
<input type="checkbox"/>	0	<input type="checkbox"/>	<input type="checkbox"/>	<input type="checkbox"/>	<input type="checkbox"/>	
<input type="checkbox"/>	0	<input type="checkbox"/>	<input type="checkbox"/>	<input type="checkbox"/>	<input type="checkbox"/>	

Add New Private VLAN

OK Cancel

To add or remove a VLAN, please refer to the following example.

- VLAN 1 is consisted of hosts linked to P1 ~ P4.
- After checking the box to enable VLAN function, you will check the table according to the needs as shown below.

LAN >> VLAN

Private VLAN Membership Configuration

Delete	PVLAN ID	LAN1	Port Members			LAN4
<input type="checkbox"/>			LAN2	LAN3		
<input checked="" type="checkbox"/>	1	<input checked="" type="checkbox"/>	<input checked="" type="checkbox"/>	<input type="checkbox"/>	<input type="checkbox"/>	
<input type="button" value="Delete"/>	<input type="text" value="2"/>	<input type="checkbox"/>	<input type="checkbox"/>	<input checked="" type="checkbox"/>	<input checked="" type="checkbox"/>	
<input type="button" value="Delete"/>	<input type="text" value="0"/>	<input type="checkbox"/>	<input type="checkbox"/>	<input type="checkbox"/>	<input type="checkbox"/>	
<input type="button" value="Delete"/>	<input type="text" value="0"/>	<input type="checkbox"/>	<input type="checkbox"/>	<input type="checkbox"/>	<input type="checkbox"/>	

- To remove VLAN, click the Delete button for the one you want to remove and click **OK** to save the results.

4.2.5 Monitor Port

It is used to monitor the traffic of the network. For example, we assume that LAN1 and LAN2 are Monitor Port and Monitor ingress Port respectively, thus, the traffic received by LAN2 will be copied to LAN1 for monitoring.

LAN >> Monitor Port

Monitor Port

Enable Monitor Port

	LAN 1	LAN 2	LAN 3	LAN 4
Monitor Port	<input checked="" type="radio"/>	<input type="radio"/>	<input type="radio"/>	<input type="radio"/>
Monitor ingress port	<input type="checkbox"/>	<input type="checkbox"/>	<input type="checkbox"/>	<input type="checkbox"/>
Monitor egress port	<input type="checkbox"/>	<input type="checkbox"/>	<input type="checkbox"/>	<input type="checkbox"/>

Enable Monitor Port

Check to enable this function.

Monitor Port

Click the one of the LAN ports to specify it for monitoring.

Monitor ingress port

Check to set up the port(s) for being monitored. It only monitors the packets **received** by the port you set up.

Monitor egress port

Check to set up the port(s) for being monitored. It only monitors the packets **transmitted** by the port you set up.

4.2.6 Static Route

Go to **LAN** to open setting page and choose **Static Route**.

LAN >> Static Route

Static Route Configuration

Index	Destination Address	Status
<input type="button" value="Add"/>		

Index

The number (1 to 10) under Index displays current static router.

Destination Address	Display the destination address of the static route.
Status	Display the status of the static route.
Add	Click it to add a new static route.

Add Static Routes to Private and Public Networks

Here is an example of setting Static Route in Main Router so that user A and B locating in different subnet can talk to each other via the router. Assuming the Internet access has been configured and the router works properly:

- use the Main Router to surf the Internet.
- create a private subnet 192.168.10.0 using an internal Router A (192.168.1.2)
- create a public subnet 211.100.88.0 via an internal Router B (192.168.1.3).
- have set Main Router 192.168.1.1 as the default gateway for the Router A 192.168.1.2.

Before setting Static Route, user A cannot talk to user B for Router A can only forward recognized packets to its default gateway Main Router.

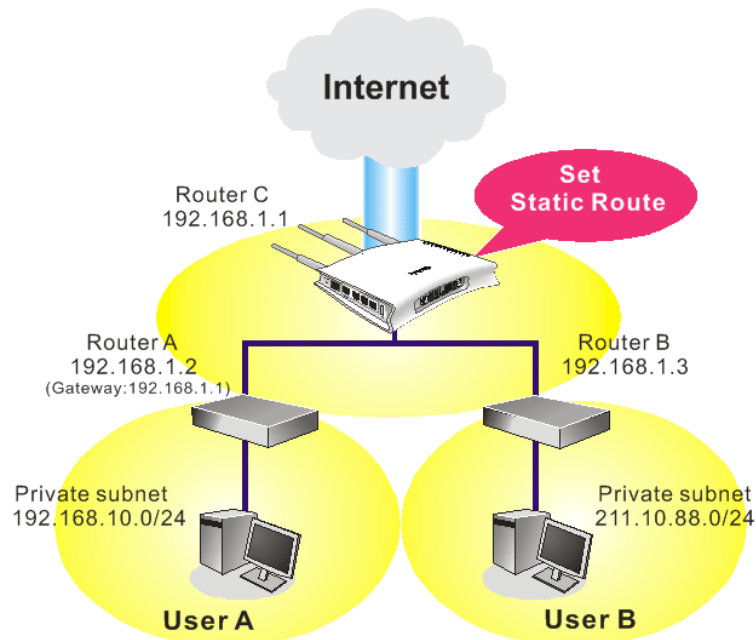

1. Click the **LAN - Static Route** and click **Add**. Check the **Enable** box. Please add a static route as shown below, which regulates all packets destined to 192.168.10.0 will be forwarded to 192.168.1.2. Click **OK**.

LAN >> Static Route

Add Static Route

<input checked="" type="checkbox"/> Enable	
Destination IP Address	192.168.10.0
Subnet Mask	255.255.255.0
Gateway IP Address	192.168.1.2

OK Cancel

- Return to **Static Route** page. Click **Add** again to add another static route as show below, which regulates all packets destined to 211.100.88.0 will be forwarded to 192.168.1.3.

LAN >> Static Route

Add Static Route

Enable

Destination IP Address

Subnet Mask

Gateway IP Address

- Verify current routing table.

LAN >> Static Route

Static Route Configuration

Index	Destination Address	Status
1	192.168.10.0/255.255.255.0	✓
2	211.100.88.0/255.255.255.0	✓

4.2.7 Bind IP to MAC

This function is used to bind the IP and MAC address in LAN to have a strengthening control in network. When this function is enabled, all the assigned IP and MAC address binding together cannot be changed. If you modified the binding IP or MAC address, it might cause you not access into the Internet.

Click **LAN** and click **Bind IP to MAC** to open the setup page.

LAN >> Bind IP to MAC

Bind IP to MAC

Note: IP-MAC binding presets DHCP Allocations.
If you select Strict Bind, unspecified LAN clients cannot access the Internet.

Enable
 Disable
 Strict Bind

ARP Table | [Select All](#) | [Sort](#) | [Refresh](#) | **IP Bind List** | [Select All](#) | [Sort](#)

IP Address	Mac Address
192.168.1.10	00:0E:A6:2A:D5:A1

Index	IP Address	Mac Address
-------	------------	-------------

Add and Edit
 IP Address
 Mac Address : : : : :

Enable	Click this radio button to invoke this function. However, IP/MAC which is not listed in IP Bind List also can connect to Internet.
Disable	Click this radio button to disable this function. All the settings on this page will be invalid.
Strict Bind	Click this radio button to block the connection of the IP/MAC which is not listed in IP Bind List.
ARP Table	This table is the LAN ARP table of this router. The information for IP and MAC will be displayed in this field. Each pair of IP and MAC address listed in ARP table can be selected and added to IP Bind List by clicking Add below.
Add and Edit	IP Address – Type the IP address that will be used for the specified MAC address. Mac Address – Type the MAC address that is used to bind with the assigned IP address.
Refresh	It is used to refresh the ARP table. When there is one new PC added to the LAN, you can click this link to obtain the newly ARP table information.
IP Bind List	It displays a list for the IP bind to MAC information.
Add	It allows you to add the one you choose from the ARP table or the IP/MAC address typed in Add and Edit to the table of IP Bind List .
Edit	It allows you to edit and modify the selected IP address and MAC address that you create before.
Remove	You can remove any item listed in IP Bind List . Simply click and select the one, and click Remove . The selected item will be removed from the IP Bind List .

Note: Before you select **Strict Bind**, you have to bind one set of IP/MAC address for one PC. If not, no one of the PCs can access into Internet. And the web configurator of the router might not be accessed.

4.3 NAT

Usually, the router serves as an NAT (Network Address Translation) router. NAT is a mechanism that one or more private IP addresses can be mapped into a single public one. Public IP address is usually assigned by your ISP, for which you may get charged. Private IP addresses are recognized only among internal hosts.

When the outgoing packets destined to some public server on the Internet reach the NAT router, the router will change its source address into the public IP address of the router, select the available public port, and then forward it. At the same time, the router shall list an entry in a table to memorize this address/port-mapping relationship. When the public server response, the incoming traffic, of course, is destined to the router's public IP address and the router will do the inversion based on its table. Therefore, the internal host can communicate with external host smoothly.

The benefit of the NAT includes:

- **Save cost on applying public IP address and apply efficient usage of IP address.** NAT allows the internal IP addresses of local hosts to be translated into one public IP address, thus you can have only one IP address on behalf of the entire internal hosts.

- **Enhance security of the internal network by obscuring the IP address.** There are many attacks aiming victims based on the IP address. Since the attacker cannot be aware of any private IP addresses, the NAT function can protect the internal network.

On NAT page, you will see the private IP address defined in RFC-1918. Usually we use the 192.168.1.0/24 subnet for the router. As stated before, the NAT facility can map one or more IP addresses and/or service ports into different specified services. In other words, the NAT function can be achieved by using port mapping methods.

Below shows the menu items for NAT.

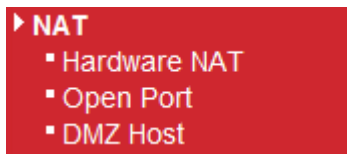

4.3.1 Hardware NAT

Hardware-base Acceleration Engine, also named Protocol Processing Engine API is the function that Draytek provides to extremely speed up the NAT performance.

While the hardware acceleration mechanism is activated, most of the bandwidth usage will be concentrated on the specific sessions which increase transmission speed to get ultimately accelerated.

With Hardware NAT, LAN to WAN NAT throughput can be over 900M bps. But be sure that your PC has Giga Ethernet and connect with CAT6 Ethernet cable.

NAT >> Hardware NAT

Hardware NAT Configuration

Hardware NAT	Enabled <input type="button" value="v"/>
<input type="button" value="OK"/> <input type="button" value="Cancel"/>	

4.3.2 Open Ports

Open Ports allows you to open a range of ports for the traffic of special applications.

NAT >> Open Port

Port Forwarding

Name	Protocol	Start Port	End Port	Local Host	Local Port
<i>No Port Forwarding</i>					

Common application of Open Ports includes P2P application (e.g., BT, KaZaA, Gnutella, WinMX, eMule and others), Internet Camera etc. Ensure that you keep the application involved up-to-date to avoid falling victim to any security exploits.

To add a new open port, click **Add new entry**.

NAT >> Open Port

Add Port Forwarding Entry

Name	<input type="text"/>
Protocol	TCP+UDP ▾
Start Port	<input type="text"/>
End Port (optional)	<input type="text"/>
Local Host	<input type="text"/>
Local Port (optional)	<input type="text"/>

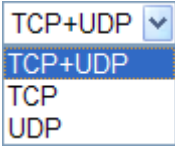
- Name** Specify the name for the defined network service.
- Protocol** Specify the transport layer protocol. It could be **TCP**, **UDP** and **TCP+UDP**.
- 
- Start Port** Specify the starting port number of the service offered by the local host.
- End Port (optional)** Specify the ending port number of the service offered by the local host.
- Local Host** Enter the private IP address of the local host.
- Local Port (optional)** If it is configured, the forwarded traffic is mapped to this port on the local host.

4.3.3 DMZ Host

As mentioned above, **Port Redirection** can redirect incoming TCP/UDP or other traffic on particular ports to the specific private IP address/port of host in the LAN. However, other IP protocols, for example Protocols 50 (ESP) and 51 (AH), do not travel on a fixed port. Vigor router provides a facility **DMZ Host** that maps ALL unsolicited data on any protocol to a single host in the LAN. Regular web surfing and other such Internet activities from other clients will continue to work without inappropriate interruption. **DMZ Host** allows a defined internal user to be totally exposed to the Internet, which usually helps some special applications such as Netmeeting or Internet Games etc.

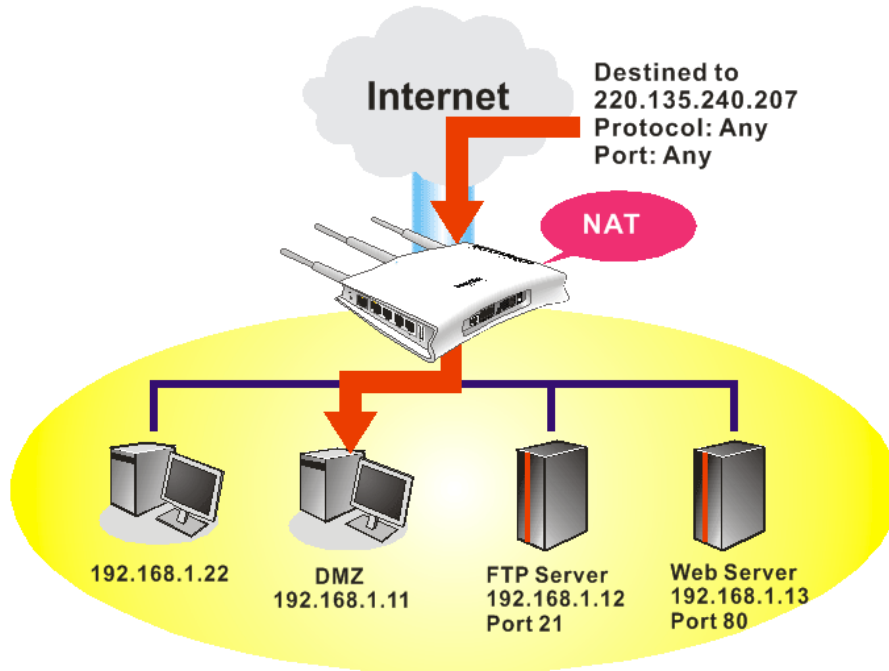

The security properties of NAT are somewhat bypassed if you set up DMZ host. We suggest you to add additional filter rules or a secondary firewall.

Click **DMZ Host** to open the following page:

NAT >> DMZ Host

DMZ Host

Enable

DMZ IP

Enable

Check to enable the DMZ Host function.

DMZ IP

Enter the private IP address of the DMZ host, or click **Choose PC** to specify a suitable one.

4.4 Firewall

Basics for Firewall

While the broadband users demand more bandwidth for multimedia, interactive applications, or distance learning, security has been always the most concerned. The firewall of the Vigor router helps to protect your local network against attack from unauthorized outsiders. It also restricts users in the local network from accessing the Internet. Furthermore, it can filter out specific packets that trigger the router to build an unwanted outgoing connection.

Denial of Service (DoS) Defense

The **DoS Defense** functionality helps you to detect and mitigate the DoS attack. The attacks are usually categorized into two types, the flooding-type attacks and the vulnerability attacks. The flooding-type attacks will attempt to exhaust all your system's resource while the vulnerability attacks will try to paralyze the system by offending the vulnerabilities of the protocol or operation system.

The **DoS Defense** function enables the Vigor router to inspect every incoming packet based on the attack signature database. Any malicious packet that might duplicate itself to paralyze the host in the secure LAN will be strictly blocked and a Syslog message will be sent as warning, if you set up Syslog server.

Also the Vigor router monitors the traffic. Any abnormal traffic flow violating the pre-defined parameter, such as the number of thresholds, is identified as an attack and the Vigor router will activate its defense mechanism to mitigate in a real-time manner.

Below shows the menu items for Firewall.



4.4.1 DoS Defense

Click **Firewall** and click **DoS Defense** to open the setup page. Storm control for the switch is configured on this page.

Firewall >> DoS Defense

Storm Control Configuration

Frame Type	Status	Rate (pps)
Unicast	<input checked="" type="checkbox"/>	1
Multicast	<input type="checkbox"/>	1
Broadcast	<input type="checkbox"/>	1

OK Cancel

Frame Type

Set the Unicast storm rate control, multicast storm rate control, and a broadcast storm rate control for your router.

Status

Check this box to enable storm control status for the frame type.

Rate

The unit is packet per second (pps). Use the drop down list to set the rate for data transmission. The rate is 2^n , where n is equal to or less than 15, or "No Limit". The unit of the rate can be either pps (packets per second) or kpps (kilopackets per

second). The configuration indicates the permitted packet rate for unicast, multicast, or broadcast traffic across the switch.

4.4.2 Ports Configuration

This page is used to configure the ACL (Access Control List) parameters for each port. These parameters will affect data packets received on a port unless the data packets match a specific ACE (Access Control Entry).

Firewall >> Ports Configuration

Ports Configuration

Refresh Clear

Port	Action	Rate Limiter ID	Counter
WAN	Allow	Disabled	17411
LAN1	Allow	Disabled	0
LAN2	Allow	Disabled	14805
LAN3	Allow	Disabled	0
LAN4	Allow	Disabled	0

OK Cancel

Port

There is one WAN port and 4 LAN ports in Vigor2130. Here each port will be configured with different ID, action, rate limiter ID, port copy and etc.

Action

Select whether forwarding is permitted ("Allow") or denied ("Deny"). The default value is "Allow".

Action

Allow
Deny
Allow

Rate Limiter ID

Select a rate limiter to apply to this port. Available settings include **Disabled**, and 1 to 10. The default value is **Disabled**.

Rate Limiter ID

Disabled
Disabled
1
2
3
4
5
6
7
8
9
10

Counter

Counts the number of frames that match this Access Control Entry (ACE).

Refresh

Click this button to refresh the number of the counter immediately.

Clear

Click this button to clear the number of the counter on this page.

Rate Limiter ID

Configure the rate limiter for the ACL (Access Control List) of the router. Please click **Rate Limiter ID** link to access into the following page.

[Firewall >> Rate Control Object](#)

ACL Rate Limiter Configuration

Rate Limiter ID	Rate (pps)
1	1
2	1
3	1
4	1
5	1
6	1
7	1
8	1
9	1
10	1

OK

Cancel

Rate Limiter ID

Rate limiter ID will be applied to WAN port and LAN port. Please specify a rate number for each ID. The default setting is "1"(packet per second).

Rate

Define the rate by choosing from the following drop down list.

1
2
4
8
16
32
64
128
256
512
1K
2K
4K
8K
16K
32K
64K
128K
256K
512K
1024K
1

4.4.3 Access Control List

This page can define which kind of packet can access the router. The packet can be defined with input port, Frame type, Rate, MAC type, VLAN ID, tag and etc.. For IPv4, we can also define the protocol type, source IP and destination IP.

Firewall >> Access Control List

Access Control List Configuration

Auto-refresh

Status	Ingress Port	Frame Type	Action	Rate Limiter	Counter

Note: This is hardware(switch) function. It won't occupy CPU resource, but not work for WLAN.

Adding a New Access Control Profile

Click  to add a new specific session limitation onto the list.

Firewall >> Access Control List

ACE Configuration

Ingress Port	Any	Action	Allow
Frame Type	IPv4	Rate Limiter	Disabled

IP Parameters

IP Protocol Filter	Any
Source IP	Any
Dest IP	Any

Define which port the packet from.

ACE Configuration

Ingress Port – define which port the packet coming from. The policy IDs are defined in **Firewall>>Port Configuration**. Each Policy ID might have more than one port grouped.

Ingress Port	Any
Frame Type	Any

Frame Type - Such option differs according to the selection you choose, we will explain it in detailed later.

Action – it means the session limitation for this access control

list will be applied to if matching with the rule defined in this page.

Action

Rate Limiter - Select a rate limiter to apply to this port. Available settings include **Disabled**, and 1 to 10. The default value is **Disabled**. Click the **Rate Limiter** link to configure different rates for each ID.

Rate Limiter

Detailed Explanation for Frame Type

Frame Type selection will lead different options for configuration.

Ingress Port

Frame Type

- Choose **Ethernet Type** as the Frame Type, you will get **Ethernet Type Parameters** option as the following:

Ethernet Type Parameters

EtherType Filter

Ethernet Type Filter

Choose **Any** to set the parameter with any value set by the router automatically or choose **Specific** to specify certain value (the range is 0x0000 to 0xFFFF).

Ethernet Type Parameters

EtherType Filter

Ethernet Type Value

- Choose **ARP** as the Frame Type, you will get **ARP Parameters** option as the following:

ARP Parameters

ARP/RARP	ARP
Request/Reply	Any
Sender IP Filter	Network
Sender IP Address	192.168.1.1
Sender IP Mask	255.255.255.0
Target IP Filter	Network
Target IP Address	192.168.1.254
Target IP Mask	255.255.255.0

ARP SMAC Match	Any
RARP DMAC Match	Any
IP/Ethernet Length	Any
IP	Any
Ethernet	Any

ARP/RARP

Choose the ARP/RARP that you want to filter.

ARP/RARP

Other

- Any
- ARP
- RARP
- Other

Request/Reply

Choose the request or replay that you want to filter.

Request/Reply

Any

- Any
- Request
- Reply

Sender IP Filter

Specify the sender IP filter for this ACE.

Sender IP Filter

Any

- Any
- Host
- Network

Choose **Any** to filter all of the packets.

Choose **Host** to filter the packets from the host with the address typed in Sender IP Address field.

Choose **Network** to filter the packets within the network defined in **Sender IP Address** and **Sender IP Mask** fields.

Sender IP Address

Type the Sender IP Address here. This option is available when you choose **Host** or **Network** as Sender IP Filter.

Sender IP Mask

Type the Sender IP Mask here. This option is available only when you choose **Network** as Sender IP Filter.

Target IP Filter

Specify the target IP filter for this specific ACE.

Target IP Filter

Any

- Any
- Host
- Network

Choose **Any** to filter all of the packets.

Choose **Host** to filter the packets from the host with the address typed in Target IP Address field.

Choose **Network** to filter the packets within the network defined in **Target IP Address** and **Target IP Mask** fields.

Target IP Address

Type the Target IP Address here. This option is available when you choose **Host** or **Network** as Target IP Filter.

Target IP Mask

Type the Target IP Mask here. This option is available only when you choose **Network** as Target IP Filter.

ARP SMAC Match

Specify whether frames/packets can meet the action according to the sender hardware address field (SHA) settings.

ARP SMAC Match

A dropdown menu with a blue arrow icon on the right. The menu is open, showing four options: '1' (top), 'Any', '0', and '1' (bottom). The '1' at the bottom is highlighted with a blue background.

0: means sender hardware address is not equal to the SMAC address.

1: means sender hardware address is equal to the SMAC address.

Any: means any value is allowed.

RARP DMAC Match

Specify whether frames can hit the action according to their target hardware address field (THA) settings.

RARP DMAC Match

A dropdown menu with a blue arrow icon on the right. The menu is open, showing four options: '1' (top), 'Any', '0', and '1' (bottom). The '1' at the bottom is highlighted with a blue background.

0: means target hardware address is not equal to the SMAC address.

1: means target hardware address is equal to the SMAC address.

Any: means any value is allowed.

IP/Ethernet Length

Specify whether frames/packets can meet the action according to the ARP/RARP hardware address length (HLN) and protocol address length (PLN) settings.

IP/Ethernet Length

A dropdown menu with a blue arrow icon on the right. The menu is open, showing four options: '0' (top), 'Any', '0', and '1' (bottom). The '0' at the bottom is highlighted with a blue background.

0: means ARP/RARP frames/packets where the hardware address length is equal to Ethernet (0x06) and the protocol address length is equal to IPv4 (0x04) **must not** match this entry.

1: means ARP/RARP frames/packets where the hardware address length is equal to Ethernet (0x06) and the protocol address length is equal to IPv4 (0x04) **must** match this entry.

Any: Any value is allowed

IP

Specify whether frames/packets can meet the action according to their ARP/RARP hardware address space (HRD) settings.

IP

0	▼
Any	
0	
1	

0: ARP/RARP frames where the hardware address space is equal to Ethernet (1) must not match this entry.

1: ARP/RARP frames where the hardware address space is equal to Ethernet (1) must match this entry.

Any: Any value is allowed.

Ethernet

Specify whether frames can hit the action according to their ARP/RARP protocol address space (PRO) settings.

Ethernet

0	▼
Any	
0	
1	

0: ARP/RARP frames where the protocol address space is equal to IP (0x800) must not match this entry.

1: ARP/RARP frames where the protocol address space is equal to IP (0x800) must match this entry.

Any: Any value is allowed.

- Choose **IPv4** as the Frame Type. You will see **IP Parameters** on the bottom of the page. If you choose **ICMP** as **IP Protocol Filter**, you will get the page as the following:

IP Parameters

IP Protocol Filter	ICMP ▼
Source IP	Network ▼
Source IP Address	0.0.0.0
Source IP Mask	0.0.0.0
Dest IP	Network ▼
Dest IP Address	0.0.0.0
Dest IP Mask	0.0.0.0

ICMP Parameters

ICMP Type Filter	Specific ▼
ICMP Type Value	255
ICMP Code Filter	Specific ▼
ICMP Code Value	255

Source IP

Specify the Source IP filter for this ACE.

Any	▼
Any	
Host	
Network	

Any: No source IP filter is specified.

Host: Source IP filter is set to Host. Specify the source IP address in the Source IP Address field that appears.

Network: Source IP filter is set to Network. Specify the source IP address and source IP mask in the Source IP Address and Source IP Mask fields that appear.

Source IP Address

Type the Source IP Address here. This option is available when you choose **Host** or **Network** as Source IP.

Source IP Mask

Type the Source IP Mask here. This option is available only when you choose **Network** as source Source IP.

Dest IP Filter

Specify the destination IP filter for this ACE.

A dropdown menu with a blue arrow on the right. The current selection is 'Any'. The menu is open, showing three options: 'Any' (highlighted in blue), 'Host', and 'Network'.

Any: No destination IP filter is specified.

Host: Destination IP filter is set to Host. Specify the destination IP address in the Dest IP Address field that appears.

Network: Destination IP filter is set to Network. Specify the destination IP address and destination IP mask in the DIP Address and Dest IP Mask fields that appear.

Dest IP Address

Type the Dest IP Address here. This option is available when you choose **Host** or **Network** as destination Dest IP.

Dest IP Mask

Type the Dest IP Mask here. This option is available only when you choose **Network** as destination Dest IP.

ICMP Type Filter

Specify the ICMP filter for this ACE.

A dropdown menu with a blue arrow on the right. The current selection is 'Any'. The menu is open, showing two options: 'Any' (highlighted in blue) and 'Specific'.

Any: No ICMP filter is specified.

Specific: If you want to filter a specific ICMP filter with this ACE, you can enter a specific ICMP value. A field for entering an ICMP value appears.

ICMP Type Value

If you choose **Specific** as ICMP Type Filter, you have to type the ICMP Type Value manually. The allowed range is 0 to 255. A frame meeting this ACE matches this ICMP value.

ICMP Code Filter

Specify the ICMP code filter for this ACE.

A dropdown menu with a blue arrow on the right. The current selection is 'Any'. The menu is open, showing two options: 'Any' (highlighted in blue) and 'Specific'.

Any: No ICMP code filter is specified (ICMP code filter status is "don't-care").

Specific: If you want to filter a specific ICMP code filter with this ACE, you can enter a specific ICMP code value. A field for entering an ICMP code value appears.

ICMP Code Value

If you choose Specific as ICMP Code Filter, you have to type the ICMP Type Value manually. The allowed range is 0 to 255. A frame meeting this ACE matches this ICMP value.

- Choose **IPv4** as the Frame Type. You will see **IP Parameters** on the bottom of the page. If you choose **UDP** as **IP Protocol Filter**, you will get the page as the following:

IP Parameters

IP Protocol Filter	UDP
Source IP	Network
Source IP Address	192.168.1.3
Source IP Mask	255.255.255.0
Dest IP	Network
Dest IP Address	192.168.1.25
Dest IP Mask	255.255.255.0

UDP Parameters

Source Port Filter	Specific
Source Port No.	0
Dest. Port Filter	Range
Dest. Port Range	0 - 65535

Source IP

Specify the source IP filter for this ACE.

Any	▼
Any	
Host	
Network	

Any: No source IP filter is specified.

Host: Source IP filter is set to Host. Specify the source IP address in the Source IP Address field that appears.

Network: Source IP filter is set to Network. Specify the source IP address and source IP mask in the Source IP Address and Source IP Mask fields that appear.

Source IP Address

Type the Source IP Address here. This option is available when you choose **Host** or **Network** as source Source IP.

Source IP Mask

Type the Source IP Mask here. This option is available only when you choose **Network** as source Source IP.

Dest IP

Specify the destination IP filter for this ACE.

DIP Filter	Any	▼
	Any	
	Host	
	Network	

Any: No destination IP filter is specified.

Host: Destination IP filter is set to Host. Specify the destination IP address in the destination IP Address field that appears.

Network: Destination IP filter is set to Network. Specify the destination IP address and destination IP mask in the destination IP Address and destination IP Mask fields that appear.

Dest IP Address

Type the destination IP Address here. This option is available when you choose **Host** or **Network** as destination IP.

Dest IP Mask

Type the DIP Mask here. This option is available only when you choose **Network** as destination DIP.

Source Port Filter

Specify the UDP port source filter for this ACE.

Source Port Filter	Any	▼
	Any	
	Specific	
	Range	

Any: No UDP source filter is specified.

Specific: If you want to filter a specific UDP source filter with this ACE, you can enter a specific UDP source value. A field for entering a UDP source value appears.

Range: If you want to filter a specific UDP source range filter with this ACE, you can enter a specific UDP source range value. A field for entering a UDP source port range appears.

Source Port No.

Type the value if you choose **Specific** as the Source Port Filter. The allowed range is 0 to 65535. A frame meeting this ACE matches this UDP source value.

Source Port Range

Type the value if you choose **Range** as the Source Port Filter. The allowed range is 0 to 65535. A frame meeting this ACE matches this UDP source value.

Dest. Port Filter

Specify the UDP port destination filter for this ACE.

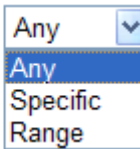
Dest. Port Filter 

Any: No UDP destination filter is specified.

Specific: If you want to filter a specific UDP destination filter with this ACE, you can enter a specific UDP destination value. A field for entering a UDP destination value appears.

Range: If you want to filter a specific UDP destination range filter with this ACE, you can enter a specific UDP destination range value. A field for entering a UDP destination port range appears.

Dest. Port No.

Type the value if you choose **Specific** as the Dest. Port Filter. The allowed range is 0 to 65535. A frame meeting this ACE matches this UDP source value.

Dest. Port Range

Type the value if you choose **Range** as the Dest. Port Filter. The allowed range is 0 to 65535. A frame meeting this ACE matches this UDP source value.

- Choose **IPv4** as the Frame Type. You will see **IP Parameters** on the bottom of the page. If you choose **TCP** as **IP Protocol Filter**, you will get the page as the following:

IP Parameters		TCP Parameters	
IP Protocol Filter	TCP	Source Port Filter	Specific
Source IP	Network	Source Port No.	0
Source IP Address	192.168.1.3	Dest. Port Filter	Range
Source IP Mask	255.255.255.0	Dest. Port Range	0 - 65535
Dest IP	Network	TCP FIN	Any
Dest IP Address	192.168.1.25	TCP SYN	Any
Dest IP Mask	255.255.255.0	TCP RST	Any
		TCP PSH	Any
		TCP ACK	Any
		TCP URG	Any

Source IP

Specify the source IP filter for this ACE.

Any: No source IP filter is specified.

Host: Source IP filter is set to Host. Specify the source IP address in the source IP Address field that appears.

Network: Source IP filter is set to Network. Specify the source IP address and source IP mask in the source IP Address and source IP Mask fields that appear.

Source IP Address

Type the source IP Address here. This option is available when you choose **Host** or **Network** as source source IP filter.

Source IP Mask

Type the SIP Mask here. This option is available only when you choose **Network** as source IP filter.

Dest IP Filter

Specify the destination IP filter for this ACE.

DIP Filter

Any: No destination IP filter is specified.

Host: Destination IP filter is set to Host. Specify the destination IP address in the destination IP Address field that appears.

Network: Destination IP filter is set to Network. Specify the destination IP address and destination IP mask in the destination IP Address and destination IP Mask fields that appear.

Dest IP Address

Type the destination IP Address here. This option is available when you choose **Host** or **Network** as destination IP filter.

Dest IP Mask

Type the destination IP Mask here. This option is available only when you choose **Network** as destination IP filter.

Source Port Filter

Specify the TCP port source filter for this ACE.

Source Port Filter 

Any: No TCP source filter is specified.

Specific: If you want to filter a specific TCP source filter with this ACE, you can enter a specific TCP source value. A field for entering a TCP source value appears.

Range: If you want to filter a specific TCP source range filter with this ACE, you can enter a specific TCP source range value. A field for entering a TCP source port range appears.

Source Port No.

Type the value if you choose **Specific** as the Source Port Filter. The allowed range is 0 to 65535. A frame meeting this ACE matches this TCP source value.

Source Port Range

Type the value if you choose **Range** as the Source Port Filter. The allowed range is 0 to 65535. A frame meeting this ACE matches this TCP source value.

Dest. Port Filter

Specify the TCP port destination filter for this ACE.

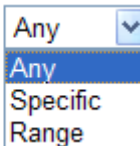
Dest. Port Filter 

Any: No TCP destination filter is specified.

Specific: If you want to filter a specific TCP destination filter with this ACE, you can enter a specific TCP destination value. A field for entering a TCP destination value appears.

Range: If you want to filter a specific TCP destination range filter with this ACE, you can enter a specific TCP destination range value. A field for entering a TCP destination port range appears.

Dest. Port No.

Type the value if you choose **Specific** as the Dest. Port filter. The allowed range is 0 to 65535. A frame meeting this ACE matches this TCP source value.

Dest. Port Range

Type the value if you choose **Range** as the Dest. Port filter. The allowed range is 0 to 65535. A frame meeting this ACE matches this TCP source value.

TCP FIN

Specify the TCP "No more data from sender" (FIN) value for this ACE.

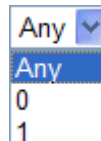

0: TCP frames where the FIN field is set must not be able to match this entry.

1: TCP frames where the FIN field is set must be able to match this entry.

Any: Any value is allowed.

TCP SYN

Specify the TCP "Synchronize sequence numbers" (SYN) value for this ACE.

 Any
 0
 1

0: TCP frames where the SYN field is set must not be able to match this entry.

1: TCP frames where the SYN field is set must be able to match this entry.

Any: Any value is allowed.

TCP RST

Specify the TCP RST value for this ACE.

 Any
 0
 1

0: TCP frames where the RST field is set must not be able to match this entry.

1: TCP frames where the RST field is set must be able to match this entry.

Any: Any value is allowed.

TCP PSH

Specify the TCP "Push Function" (PSH) value for this ACE.

 Any
 0
 1

0: TCP frames where the PSH field is set must not be able to match this entry.

1: TCP frames where the PSH field is set must be able to match this entry.

Any: Any value is allowed.

TCP ACK

Specify the TCP "Acknowledgment field significant" (ACK) value for this ACE.

 Any
 0
 1

0: TCP frames where the ACK field is set must not be able to match this entry.

1: TCP frames where the ACK field is set must be able to match this entry.

Any: Any value is allowed

TCP URG

Specify the TCP "Urgent Pointer field significant" (URG) value for this ACE.

 Any
 0
 1

0: TCP frames where the URG field is set must not be able to match this entry.

1: TCP frames where the URG field is set must be able to match this entry.

Any: Any value is allowed.

- Choose **IPv4** as the Frame Type. You will see **IP Parameters** on the bottom of the page. If you choose **Other** as **IP Protocol Filter**, you will get the page as the following:

IP Parameters

IP Protocol Filter	Other ▾
IP Protocol Value	255
Source IP	Network ▾
Source IP Address	192.168.1.3
Source IP Mask	255.255.255.0
Dest IP	Network ▾
Dest IP Address	192.168.1.25
Dest IP Mask	255.255.255.0

IP Protocol Value

When "Other" is selected for the IP protocol filter, you can enter a specific value here. The range is 0 to 255. The default value is "255". A frame meeting this ACE matches this IP protocol value.

Source IP

Specify the source IP filter for this ACE.

Any ▾
Any
Host
Network

Any: No source IP filter is specified.

Host: Source IP filter is set to Host. Specify the source IP address in the source IP Address field that appears.

Network: Source IP filter is set to Network. Specify the source IP address and source IP mask in the source IP Address and source IP Mask fields that appear.

Source IP Address

Type the source IP Address here. This option is available when you choose **Host** or **Network** as source IP Filter.

Source IP Mask

Type the source IP Mask here. This option is available only when you choose **Network** as source IP.

Dest IP

Specify the destination IP filter for this ACE.

Any ▾
Any
Host
Network

Any: No destination IP filter is specified.

Host: Destination IP filter is set to Host. Specify the destination IP address in the destination IP Address field that appears.

Network: Destination IP is set to Network. Specify the destination IP address and destination IP mask in the

destination IP address and destination IP mask fields that appear.

Dest IP Address

Type the Dest IP Address here. This option is available when you choose **Host** or **Network** as destination IP filter.

Dest IP Mask

Type the Dest IP Mask here. This option is available only when you choose **Network** as destination IP filter.

4.5 Bandwidth Management

Below shows the menu items for Bandwidth Management.



4.5.1 Session Limit

A PC with private IP address can access to the Internet via NAT router. The router will generate the records of NAT sessions for such connection. The P2P (Peer to Peer) applications (e.g., BitTorrent) always need many sessions for procession and also they will occupy over resources which might result in important accesses impacted. To solve the problem, you can use limit session to limit the session procession for specified Hosts.

In the **Bandwidth Management** menu, click **Sessions Limit** to open the web page.

Bandwidth Management >> Session Limit

Session Limit Configuration

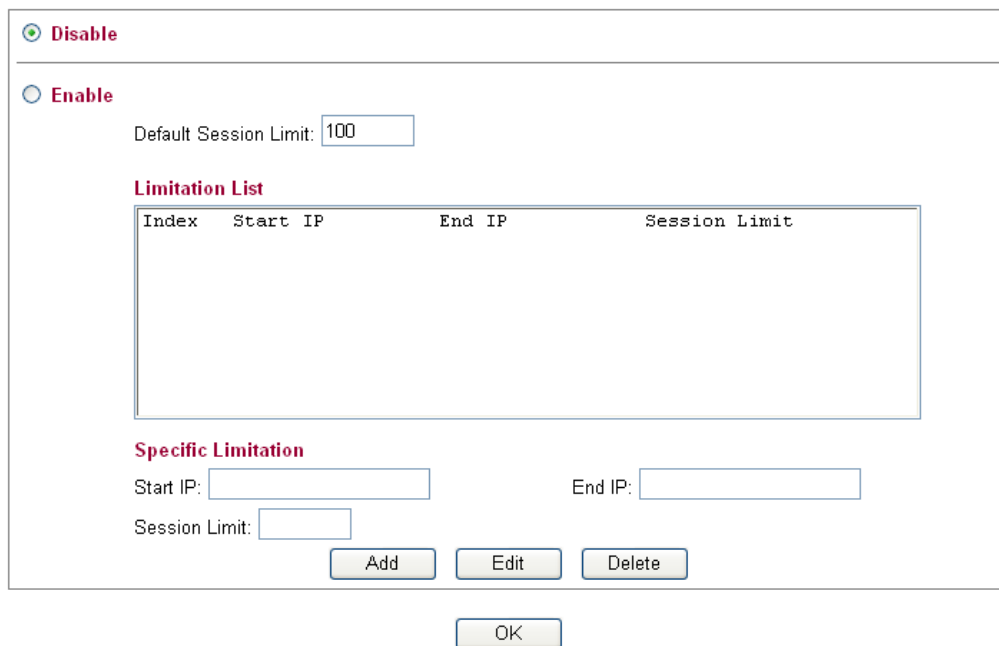

Disable

Enable

Default Session Limit:

Limitation List

Index	Start IP	End IP	Session Limit
-------	----------	--------	---------------

Specific Limitation

Start IP: End IP:

Session Limit:

To activate the function of limit session, simply click **Enable** and set the default session limit.

Enable

Click this button to activate the function of limit session.

- Disable** Click this button to close the function of limit session.
- Default Sessions Limit** Defines the default session number used for each computer in LAN.
- Limitation List** Displays a list of specific limitations that you set on this web page.
- Start IP** Defines the start LAN IP address for limit session.
- End IP** Defines the end LAN IP address for limit session.
- Sessions Limit** Defines the available session number for each host in the specific range of IP addresses. If you do not set the session number in this field, the system will use the default session limit for the specific limitation you set for each index.
- Add** Adds the specific session limitation onto the list above.
- Edit** Allows you to edit the settings for the selected limitation.
- Delete** Remove the selected settings existing on the limitation list.

When you finish adding a new session limit, simply click **OK**. The following page will appear for you to check.

4.5.2 Bandwidth Limit

The downstream or upstream from FTP, HTTP or some P2P applications will occupy large of bandwidth and affect the applications for other programs. Please use Limit Bandwidth to make the bandwidth usage more efficient.

In the **Bandwidth Management** menu, click **Bandwidth Limit** to open the web page.

[Bandwidth Management >> Bandwidth Limit](#)

Bandwidth Limit Configuration

Disable

Enable

Smart Bandwidth Limit
 When session number exceeds:
 TX Limit: Kbps RX Limit: Kbps

User-defined Bandwidth Limit

Limitation List

Index	Start IP	End IP	TX limit	RX limit

Specific Limitation

Start IP: End IP:

TX Limit: Kbps RX Limit: Kbps

1. Bandwidth limit only works for 'NEW' sessions. Original sessions are controlled by HNAT.
2. If the IP is controlled by bandwidth limit, throughput would be lower than 85Mbps.

To activate the function of limit bandwidth, simply click **Enable** and set the default or user-defined upstream and downstream limit.

Disable	Click this button to close the function of limit bandwidth.
Enable	Click this button to activate the function of limit bandwidth.
Smart Bandwidth Limit	Click this radio button to configure the default limitation for bandwidth. When session number exceeds – type the value here as a threshold to apply the smart bandwidth limit. TX limit - Define the default speed of the upstream for each computer in LAN. RX limit - Define the default speed of the downstream for each computer in LAN.
User-defined Bandwidth Limit	Click this radio button to configure the user-defined limitation for bandwidth. Limitation List - Display a list of specific limitations that you set on this web page. Start IP - Bandwidth limit can be applied on certain IP range. That's, only the PCs within the range will be influenced by the bandwidth limitation set here. Please define the start IP address for the specific limitation. End IP - Define the end IP address for the specific limitation. TX Limit - Define the limitation for the speed of the upstream to be applied as specific limitation. If you do not set the limit in this field, the system will use the default speed for the specific limitation you set for each index. RX Limit - Define the limitation for the speed of the downstream to be applied as specific limitation. If you do not set the limit in this field, the system will use the default speed for the specific limitation you set for each index. Add - Add the specific speed limitation onto the list above. Edit - Allows you to edit the settings for the selected limitation. Delete - Remove the selected settings existing on the limitation list.

When you finish adding a new bandwidth limit, simply click **OK**.

4.5.3 Port Rate Control

A policer can limit the bandwidth of received frames. It is located in front of the ingress queue. And a shaper can limit the bandwidth of transmitted frames. It is located after the ingress queues. This page allows you to configure the switch port rate limit for Policers and Shapers.

Bandwidth Management >> Port Rate Control

Rate Limit Configuration

Port	Policer Enabled	Policer Rate(Rx)	Policer Unit	Shaper Enabled	Shaper Rate(Tx)	Shaper Unit
WAN	<input type="checkbox"/>	500	kbps	<input checked="" type="checkbox"/>	10	Mbps

Note: Shaper must be enabled for Weighted Queuing Mode QoS!!

OK Cancel

Port	Represent LAN or WAN interface.
Policer Enabled	Check this box to enable policer function.
Policer Rate(Rx)	Type the number for policer function. The default value is 500. It is restricted to 500-1000000 when the Policer Unit is set in kbps, and it is restricted to 1-1000 when the Policer Unit is set in Mbps.
Policer Unit	Determine the unit (kbps/Mbps) for policer.
Shaper Enabled	Check this box to enable shaper function.
Shaper Rate (Tx)	Type the number for shaper function. The default value is 500. It is restricted to 500-1000000 when the Shaper Unit is set in kbps, and it is restricted to 1-1000 when the Shaper Unit is set in Mbps.
Shaper Unit	Determine the unit (kbps/Mbps) for shaper function.

4.5.4 QoS Control List

Deploying QoS (Quality of Service) management to guarantee that all applications receive the service levels required and sufficient bandwidth to meet performance expectations is indeed one important aspect of modern enterprise network.

One reason for QoS is that numerous TCP-based applications tend to continually increase their transmission rate and consume all available bandwidth, which is called TCP slow start. If other applications are not protected by QoS, it will detract much from their performance in the overcrowded network. This is especially essential to those are low tolerant of loss, delay or jitter (delay variation).

Another reason is due to congestions at network intersections where speeds of interconnected circuits mismatch or traffic aggregates, packets will queue up and traffic can be throttled back to a lower speed. If there's no defined priority to specify which packets should be discarded (or in another term "dropped") from an overflowing queue, packets of sensitive applications mentioned above might be the ones to drop off. How this will affect application performance?

There are two components within Primary configuration of QoS deployment:

- Classification: Identifying low-latency or crucial applications and marking them for high-priority service level enforcement throughout the network.

- **Scheduling:** Based on classification of service level to assign packets to queues and associated service types

The basic QoS implementation in Vigor routers is to classify and schedule packets based on the service type information in the IP header. For instance, to ensure the connection with the headquarter, a teleworker may enforce an index of QoS Control to reserve bandwidth for HTTPS connection while using lots of application at the same time.

One more larger-scale implementation of QoS network is to apply DSCP (Differentiated Service Code Point) and IP Precedence disciplines at Layer 3. Compared with legacy IP Precedence that uses Type of Service (ToS) field in the IP header to define 8 service classes, DSCP is a successor creating 64 classes possible with backward IP Precedence compatibility. In a QoS-enabled network, or Differentiated Service (DiffServ or DS) framework, a DS domain owner should sign a Service License Agreement (SLA) with other DS domain owners to define the service level provided toward traffic from different domains. Then each DS node in these domains will perform the priority treatment. This is called per-hop-behavior (PHB). The definition of PHB includes Expedited Forwarding (EF), Assured Forwarding (AF), and Best Effort (BE). AF defines the four classes of delivery (or forwarding) classes and three levels of drop precedence in each class.

Vigor routers as edge routers of DS domain shall check the marked DSCP value in the IP header of bypassing traffic, thus to allocate certain amount of resource execute appropriate policing, classification or scheduling. The core routers in the backbone will do the same checking before executing treatments in order to ensure service-level consistency throughout the whole QoS-enabled network.

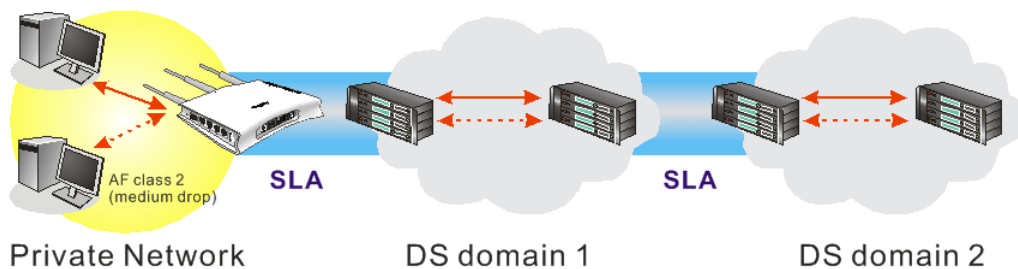

However, each node may take different attitude toward packets with high priority marking since it may bind with the business deal of SLA among different DS domain owners. It's not easy to achieve deterministic and consistent high-priority QoS traffic throughout the whole network with merely Vigor router's effort.

In the **Bandwidth Management** menu, click **QoS Control List** to open the web page.

Bandwidth Management >> QoS Control List

QoS Control List Configuration

QCL # ▼

QCE Type	Type Value	Traffic Class	
TCP/UDP Port	22 - 23	High	
TCP/UDP Port	5060	High	
TCP/UDP Port	25	Medium	
TCP/UDP Port	80	Medium	
TCP/UDP Port	110	Medium	
TCP/UDP Port	443	Medium	
DSCP	0	Low	

Note: A QCL consists of an ordered list of up to 12 QCEs.

QCE Type Display the type of that QCE (QoS Control Entries).

Type Value Display the value specified for the QCE.

Traffic Class Display the class of the data transmission for the QCE.

QoS Control List allows users to set up to **five** groups of QCL. Each QCL group can contain 12 QCE settings.

QoS Control List Configuration

QCL # ▼

1
2
3
4
5

QCE Type	Type Value
TCP/UDP Port	22 - 23

Adding a New QCE

Click to add a new QCE onto this page. Different QCE type will bring out different web settings.

- If you choose **Ethernet Type** as QCE Type, you have to type value for it and specify traffic class from Low, Normal, Medium and High.

Bandwidth Management >> QoS Control List

QCE Configuration

QCE Type	Ethernet Type
Ethernet Type Value	0xFFFF
Traffic Class	Low

Low
Normal
Medium
High

OK Cancel

Ethernet Type Value Either **8~63** ASCII characters, such as 012345678(or 64 Hexadecimal digits leading by 0x, such as "0x321253abcde...").

- If you choose **VLAN ID** as QCE Type, you have to type the ID number for it and specify traffic class from Low, Normal, Medium and High.

Bandwidth Management >> QoS Control List

QCE Configuration

QCE Type	VLAN ID
VLAN ID	1
Traffic Class	Low

Low
Normal
Medium
High

OK Cancel

- If you choose **TCP/UDP Port** as QCE Type, you have to type the port number for it and specify traffic class from Low, Normal, Medium and High.

Bandwidth Management >> QoS Control List

QCE Configuration

QCE Type	TCP/UDP Port
TCP/UDP Port	Range
TCP/UDP Port Range	0 - 65535
Traffic Class	Low

Low
Normal
Medium
High

OK Cancel

TCP/UDP Port Click **Single** or **Range**. If you select Range, you have to type in the starting port number and the end porting number on the boxes below.

TCP/UDP Port Range Type in the starting port number and the end porting number here if you choose Range as the type.

- If you choose **DSCP** as QCE Type, you have to type value for it and specify traffic class from Low, Normal, Medium and High.

Bandwidth Management >> QoS Control List

QCE Configuration

QCE Type	DSCP
DSCP Value	63
Traffic Class	Low

Low
Normal
Medium
High

OK Cancel

- If you choose **ToS** as QCE Type, you have to specify priority class from Low, Normal, Medium and High.

Bandwidth Management >> QoS Control List

QCE Configuration

QCE Type	ToS
ToS Priority 0 Class	Low
ToS Priority 1 Class	Low
ToS Priority 2 Class	Low
ToS Priority 3 Class	Low
ToS Priority 4 Class	Low
ToS Priority 5 Class	Low
ToS Priority 6 Class	Low
ToS Priority 7 Class	Low

Low
Normal
Medium
High

OK Cancel

- If you choose **Tag Priority** as QCE Type, you have to specify priority class from Low, Normal, Medium and High.

Bandwidth Management >> QoS Control List

QCE Configuration

QCE Type	Tag Priority
Tag Priority 0 Class	Normal
Tag Priority 1 Class	Low
Tag Priority 2 Class	Low
Tag Priority 3 Class	Normal
Tag Priority 4 Class	Medium
Tag Priority 5 Class	Medium
Tag Priority 6 Class	High
Tag Priority 7 Class	High



Low
Normal
Medium
High

OK Cancel

Editing a QCE

Click  to modify the settings of an existing QCE on this page.

Moving Up/Down a QCE

Click  and  to move a QCE up and down.

Deleting a QCE

To delete a QCE in the list, simply click  of that one. It will be removed immediately.

4.5.5 Ports Priority

This page allows you to configure QoS settings for each port. The classification is controlled by a QCL (Quality Control List) that is assigned to each port. A QCL consists of an ordered list of up to 12 QCEs (Quality Control Entry). Each QCE can be used to classify certain frames to a specific QoS class. This classification can be based on parameters such as VLAN ID, UDP/TCP port, IPv4/IPv6 DSCP or Tag Priority. Frames not matching any of the QCEs are classified to the default QoS class for the port.

Bandwidth Management >> Ports Priority

Port QoS Configuration

Port	Default Class	QCL #	Queuing Mode	Low	Queuing Weighted Normal	Medium	High
WAN	Normal	1	Weighted	1	2	4	8

Port Indicate the interface for the physical port, WAN port, LAN port and Wireless Port.

Default Class Use the drop down list to choose the priority for each port.

Default Class

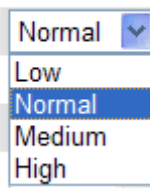

A dropdown menu showing the following options: Normal (selected), Low, Normal, Medium, High.

QCL Use the drop down list to choose the QCL number defined in QoS Control List for the port.

QCL

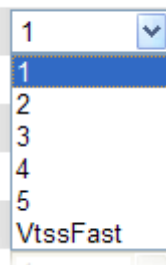

A dropdown menu showing the following options: 1 (selected), 2, 3, 4, 5, VtssFast.

Queuing Mode Use the drop down list to choose suitable mode.

Queuing Mode

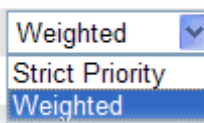

A dropdown menu showing the following options: Weighted (selected), Strict Priority, Weighted.

Queue Weighted

Use the drop down list to choose 1, 2, 4, or 8 as the queue weighted number.

4.5.6 QoS Statistics

This page displays statistics for QoS setting. Click WAN/LAN link to check detailed information for each interface.

Bandwidth Management >> QoS Statistics

Queuing Counters

Auto-refresh Refresh Clear

Port	Low Queue		Normal Queue		Medium Queue		High Queue	
	Receive	Transmit	Receive	Transmit	Receive	Transmit	Receive	Transmit
WAN	58350	61843	69518	0	76195	63030	22	12
LAN1	0	0	0	0	0	0	0	0
LAN2	57361	7575	1953	61191	66042	75655	21	0
LAN3	0	0	0	0	0	0	0	0
LAN4	0	0	0	0	0	0	0	0

Click [WAN/LAN](#) link to check detailed information for each interface.

Diagnostics >> Detailed Statistics

Detailed Port Statistics WAN

[WAN](#) Auto-refresh Refresh Clear

Receive Total		Transmit Total	
Rx Packets	6320	Tx Packets	2492
Rx Octets	1729133	Tx Octets	996250
Rx Unicast	3129	Tx Unicast	2489
Rx Multicast	200	Tx Multicast	0
Rx Broadcast	2991	Tx Broadcast	3
Rx Pause	0	Tx Pause	0
Receive Size Counters		Transmit Size Counters	
Rx 64 Bytes	3502	Tx 64 Bytes	1367
Rx 65-127 Bytes	1106	Tx 65-127 Bytes	433
Rx 128-255 Bytes	698	Tx 128-255 Bytes	16
Rx 256-511 Bytes	149	Tx 256-511 Bytes	82
Rx 512-1023 Bytes	58	Tx 512-1023 Bytes	27
Rx 1024-1526 Bytes	807	Tx 1024-1526 Bytes	567
Rx 1527- Bytes	0	Tx 1527- Bytes	0
Receive Queue Counters		Transmit Queue Counters	
Rx Low	4286	Tx Low	1385
Rx Normal	813	Tx Normal	0
Rx Medium	1217	Tx Medium	1107
Rx High	4	Tx High	0
Receive Error Counters		Transmit Error Counters	
Rx Drops	0	Tx Drops	0
Rx CRC/Alignment	0	Tx Late/Exc. Coll.	0
Rx Undersize	0		
Rx Oversize	0		
Rx Fragments	0		
Rx Jabber	0		
Rx Filtered	0		

Rx Packets

Display the counting number of the packet received.

Rx Octets	Display the total received bytes.
Rx Unicast	Display the counting number of the received unicast packet.
Rx Broadcast	Display the counting number of the received broadcast packet.
Rx Pause	Display the counting number of the received pause packet.
RX 64 Bytes	Display the number of 64-byte frames in good and bad packets received.
RX 65-127 Bytes	Display the number of 65 ~ 127-byte frames in good and bad packets received.
RX 128-255 Bytes	Display the number of 128 ~ 255-byte frames in good and bad packets received.
RX 256-511 Bytes	Display the number of 256 ~ 511-byte frames in good and bad packets received.
RX 512-1023 Bytes	Display the number of 512 ~ 1023-byte frames in good and bad packets received.
RX 1024- 1526 Bytes	Display the number of 1024-1522-byte frames in good and bad packets received.
RX 1527 Bytes	Display the number of 1527-byte frames in good and bad packets received.
Rx Low	Display the low queue counter of the packet received.
Rx Normal	Display the normal queue counter of the packet received.
Rx Medium	Display the medium queue counter of the packet received.
Rx High	Display the high queue counter of the packet received.
Rx Drops	Display the number of frames dropped due to the lack of receiving buffer.
Rx CRC/Alignment	Display the number of Alignment errors packets received.
Rx Undersize	Display the number of short frames (<64 Bytes) with valid CRC.
Rx Oversize	Display the number of long frames (according to max_length register) with valid CRC.
Rx Fragments	Display the number of short frames (< 64 bytes) with invalid CRC.
Rx Jabber	Display the number of long frames (according to max_length register) with invalid CRC.
Rx Filtered	Display the filtered number of the packet received.
Tx Packets	Display the the counting number of the packet transmitted.
Tx Octets	Display the total transmitted bytes.
Tx Unicast	Display the show the counting number of the transmitted unicast packet.
Tx Multicast	Display the show the counting number of the transmitted multicast packet.
Tx Broadcast	Display the counting number of the transmitted broadcast packet.

Tx Pause	Show the counting number of the transmitted pause packet.
Tx 64 Bytes	Display the number of 64-byte frames in good and bad packets transmitted.
Tx 65-127 Bytes	Display the number of 65 ~ 127-byte frames in good and bad packets transmitted.
Tx 128-255 Bytes	Display the number of 128 ~ 255-byte frames in good and bad packets transmitted.
Tx 256-511 Bytes	Display the number of 256 ~ 511-byte frames in good and bad packets transmitted.
Tx 512-1023 Bytes	Display the number of 512 ~ 1023-byte frames in good and bad packets transmitted.
Tx 1024- 1526 Bytes	Display the number of 1024 ~ 1522-byt frames in good and bad packets transmitted.
Tx 1527 Bytes:	Display the number of 1527-byte frames in good and bad packets transmitted.
Tx Low	Display the low queue counter of the packet transmitted.
Tx Normal	Display the normal queue counter of the packet transmitted.
Tx Medium	Display the medium queue counter of the packet received.
Tx High	Display the high queue counter of the packet received.
Tx Drops	Display the number of frames dropped due to excessive collision, late collision, or frame aging.
Tx lat/Exc.Coll.	Display the number of Frames late collision or excessive collision Error, which switch transmitted.

4.6 Applications

Below shows the menu items for Applications.



4.6.1 Dynamic DNS

The ISP often provides you with a dynamic IP address when you connect to the Internet via your ISP. It means that the public IP address assigned to your router changes each time you access the Internet. The Dynamic DNS feature lets you assign a domain name to a dynamic WAN IP address. It allows the router to update its online WAN IP address mappings on the specified Dynamic DNS server. Once the router is online, you will be able to use the registered domain name to access the router or internal virtual servers from the Internet. It is particularly helpful if you host a web server, FTP server, or other server behind the router.

Before you use the Dynamic DNS feature, you have to apply for free DDNS service to the DDNS service providers. The router provides up to three accounts from three different DDNS service providers. Basically, Vigor routers are compatible with the DDNS services supplied by most popular DDNS service providers such as www.dyndns.org, www.no-ip.com,

www.dtdns.com, www.changeip.com, www.dynamic-nameserver.com. You should visit their websites to register your own domain name for the router.

Applications >> Dynamic DNS

Dynamic DNS Configuration

Enable Dynamic DNS	<input type="checkbox"/>
Service Provider	dyndns.org
Domain name	mypersonaldomain.dyndns.org
Username	myusername
Password	•••••
Check IP change every	10 minutes
Force IP update every	72 hours

- Enable Dynamic DNS** Check this box to enable the current account.
- DynDNS Service** Select the service provider for the DDNS account.
- Hostname** Type in one domain name that you applied previously. Use the drop down list to choose the desired domain.
- Username** Type in the login name that you set for applying domain.
- Password** Type in the password that you set for applying domain.
- Check IP change every** Set the interval for checking the information.
- Force IP update every** Force the router updates its information to DDNS server with the interval set here.

Click **OK** button to activate the settings. You will see your setting has been saved.

4.6.2 Schedule

The Vigor router has a built-in real time clock which can update itself manually or automatically by means of Network Time Protocols (NTP). As a result, you can not only schedule the router to dialup to the Internet at a specified time, but also restrict Internet access to certain hours so that users can connect to the Internet only during certain hours, say, business hours. The schedule is also applicable to other functions.

You have to set your time before set schedule. In **System Maintenance>> Time and Date** menu, press **Inquire Time** button to set the Vigor router's clock to current time of your PC. The clock will reset once if you power down or reset the router. There is another way to set up time. You can inquiry an NTP server (a time server) on the Internet to synchronize the router's clock. This method can only be applied when the WAN connection has been built up.

Applications >> Schedule

Index	Setting	Status
<input type="button" value="Add"/>		

You can set up to **15** schedules. To add a schedule profile, please click **Add**.

Add Schedule

Enable

Start Date: 2000 - 1 - 1 (Year - Month - Date)

Start Time: 0 : 0 (Hour : Minute)

Action: WAN UP

Acts: Once

Weekday: Monday Tuesday Wednesday Thursday Friday Saturday Sunday

OK Cancel

Enable

Check to enable the schedule.

Start Date

Specify the starting date of the schedule.

Start Time

Specify the starting time of the schedule.

Action

Specify which action should be applied during the period of the schedule.

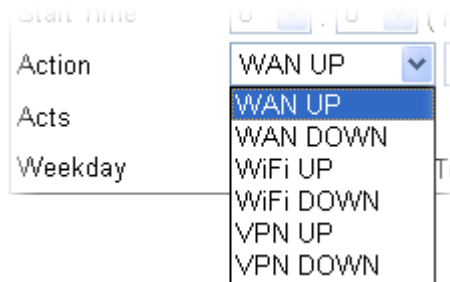

WAN UP/DOWN – WAN connection will be activated / inactivated based on the time schedule configured here.

WiFi UP/DOWN – Wireless Wi-Fi connection will be activated / inactivated based on the time schedule configured here.

VPN UP/DOWN - VPN connection will be activated / inactivated based on the time schedule configured here.

Acts

Specify how often the schedule will be applied

Once -The schedule will be applied just once

Routine /Weekday -Specify which days in one week should perform the schedule.

4.6.3 IGMP Snooping

IGMP snooping means multicast traffic will be forwarded to ports that have members of that group. If you disable IGMP snooping, the system will make multicast traffic treated in the same manner as broadcast traffic.

[Applications >> IGMP Snooping](#)

IGMP Snooping Configuration

General Configuration	
Snooping Enabled	<input type="checkbox"/>
Unregistered IPMC Flooding enabled	<input type="checkbox"/>

Port Related Configuration

Port	Fast Leave
LAN1	<input type="checkbox"/>
LAN2	<input type="checkbox"/>
LAN3	<input type="checkbox"/>
LAN4	<input type="checkbox"/>

Snooping Enabled

Check the box to enable this function.

Unregistered IPMC...

Check the box to enable unregistered IPMC traffic flooding

Fast Leave

Check the box to Fast Leave on the LAN port.

4.6.4 IGMP Status

This page display current IGMP status.

[Applications >> IGMP Status](#)

IGMP Snooping Status

Auto-refresh

Statistics

V1 Reports Receive	V2 Reports Receive	V3 Reports Receive	V2 Leave Receive
0	0	0	0

IGMP Groups

Groups	Port Members
No IGMP groups	1 2 3 4

V1~3 Reports Receive

Display the number of Received V1 – V3 Reports.

V2 Leave Receive

Display the number of Received V2 Leave.

Groups

Display current IGMP groups. Maximum number of group for each VLAN can be set is 128.

Port Members

Display the LAN ports in this group.

Refresh

Click this button to refresh the page immediately.

Clear

Click this button to clear the settings on this page.

4.6.5 UPnP Configuration

The **UPnP** (Universal Plug and Play) protocol is supported to bring to network connected devices the ease of installation and configuration which is already available for directly connected PC peripherals with the existing Windows 'Plug and Play' system. For NAT routers, the major feature of UPnP on the router is "NAT Traversal". This enables applications inside the firewall to automatically open the ports that they need to pass through a router. It is more reliable than requiring a router to work out by itself which ports need to be opened. Further, the user does not have to manually set up port mappings or a DMZ. **UPnP is available on Windows XP** and the router provide the associated support for MSN Messenger to allow full use of the voice, video and messaging features.

Applications >> UPnP Configuration

UPnP Configuration

Enable UPnP	<input checked="" type="checkbox"/>
Download Speed	<input type="text" value="1024"/> kbps
Upload Speed	<input type="text" value="512"/> kbps

Enable UPnP

Enable UPnP function. You have to type the download and upload speed.

Download Speed

Enter the maximum sustained WAN download speed in kilobits/second. Such information can be requested by UPnP clients.

Upload Speed

Enter the maximum sustained WAN upload speed in kilobits/second. Such information can be requested by UPnP clients.

After setting **Enable UPnP** setting, an icon of **IP Broadband Connection on Router** on Windows XP/Network Connections will appear. The connection status and control status will be able to be activated. The NAT Traversal of UPnP enables the multimedia features of your applications to operate. This has to manually set up port mappings or use other similar methods. The screenshots below show examples of this facility.

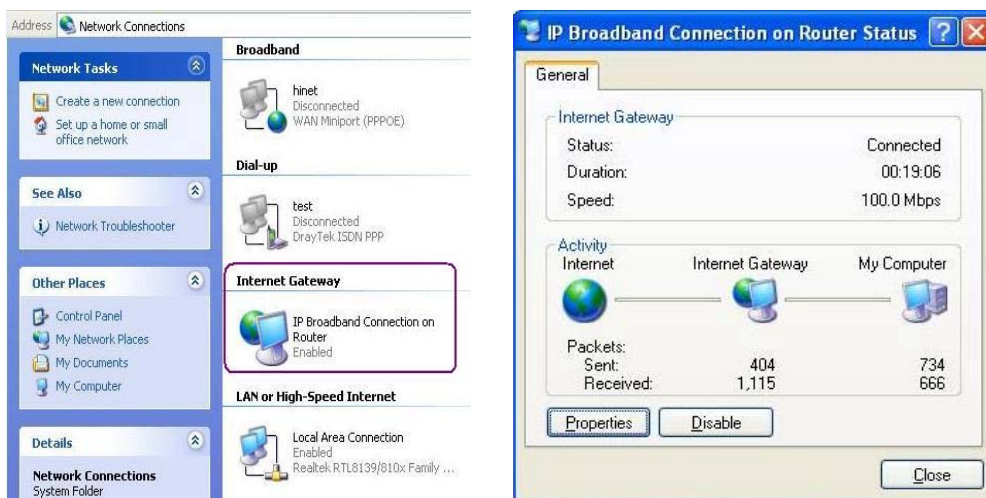

The UPnP facility on the router enables UPnP aware applications such as MSN Messenger to discover what are behind a NAT router. The application will also learn the external IP address and configure port mappings on the router. Subsequently, such a facility forwards packets from the external ports of the router to the internal ports used by the application.

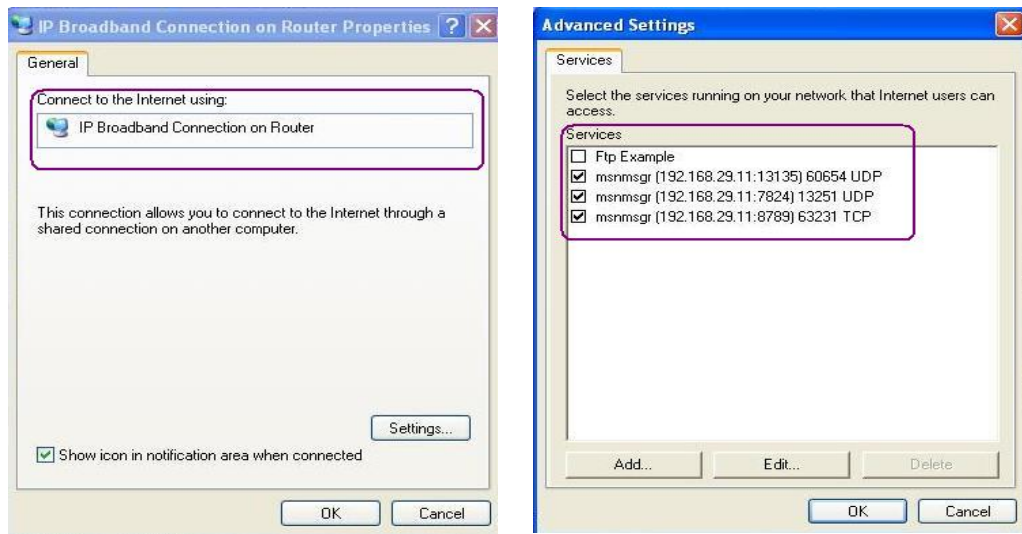

The reminder as regards concern about Firewall and UPnP

Can't work with Firewall Software

Enabling firewall applications on your PC may cause the UPnP function not working properly. This is because these applications will block the accessing ability of some network ports.

Security Considerations

Activating the UPnP function on your network may incur some security threats. You should consider carefully these risks before activating the UPnP function.

- Some Microsoft operating systems have found out the UPnP weaknesses and hence you need to ensure that you have applied the latest service packs and patches.
- Non-privileged users can control some router functions, including removing and adding port mappings.

The UPnP function dynamically adds port mappings on behalf of some UPnP-aware applications. When the applications terminate abnormally, these mappings may not be removed.

4.6.6 Wake On LAN

A PC client on LAN can be woken up by the router it connects. When a user wants to wake up a specified PC through the router, he/she must type correct MAC address of the specified PC on this web page of **Wake On LAN** of this router.

In addition, such PC must have installed a network card supporting WOL function. By the way, WOL function must be set as “Enable” on the BIOS setting.

[Applications >> Wake on LAN](#)

Wake on LAN

Note: Wake on LAN integrates with [Bind IP to MAC](#) function, only binded PCs can wake up through IP.

Wake by:

IP Address:

MAC Address: : : : : :

Result

Wake by

Two types provide for you to wake up the binded IP. If you choose Wake by MAC Address, you have to type the correct MAC address of the host in MAC Address boxes. If you choose Wake by IP Address, you have to choose the correct IP address.

Wake by:

IP Address

The IP addresses that have been configured in **LAN>>Bind IP to MAC** will be shown in this drop down list. Choose the IP address from the drop down list that you want to wake up.

MAC Address

Type any one of the MAC address of the binded PCs.

Wake Up

Click this button to wake up the selected IP. See the following figure. The result will be shown on the box.

4.7 VPN and Remote Access

A Virtual Private Network (VPN) is the extension of a private network that encompasses links across shared or public networks like the Internet. In short, by VPN technology, you can send data between two computers across a shared or public network in a manner that emulates the properties of a point-to-point private link.

Below shows the menu items for VPN and Remote Access.

- ▶ **VPN and Remote Access**
 - Remote Access Control
 - PPTP Remote Dial-in
 - IPsec Remote Dial-in
 - Remote Dial-in Status
 - LAN to LAN

4.7.1 Remote Access Control

Enable the necessary VPN service as you need. If you intend to run a VPN server inside your LAN, you should enable IPsec VPN Pass-through and specify an IP address to allow VPN tunnel pass through.

VPN and Remote Access >> Remote Access Control

Remote Access Control Setup

Enable IPsec VPN Service	<input checked="" type="checkbox"/>
Enable IPsec VPN Pass-through (Server inside your LAN)	<input type="checkbox"/> 0.0.0.0
Enable PPTP VPN Service	<input checked="" type="checkbox"/>
IP Address range for PPTP client	192.168.1.201-192.168.1.250
IP Address range for DHCP client	192.168.1.10-192.168.1.59
Enable PPTP VPN Pass-through (Server inside your LAN)	<input type="checkbox"/> 0.0.0.0

OK

Enable IPsec VPN Service

If this checkbox is checked, the system firewall will allow VPN (IPsec) remote access from WAN side to the router.

Enable IPsec VPN Pass-through (Server inside your LAN)

If this checkbox is checked, the system firewall will allow VPN (IPsec) remote access from WAN side to a VPN device on the LAN. Type the IP address of the VPN device in the field next to the checkbox.

Enable PPTP VPN Service

If this checkbox is checked, the system firewall will allow VPN (PPTP) remote access from WAN side to the router.

IP Address range for PPTP client – Specify an IP address pool for the local private network that will be assigned to PPTP clients. Note the values given here should not be the same as **IP address range for DHCP Client**.

IP Address range for DHCP client – Display the range of IP address assigned by DHCP server.

Enable PPTP VPN Pass-through (Server inside your LAN)

If this checkbox is checked, the system firewall will pass VPN (PPTP) remote access from WAN side to a VPN server in the LAN. Type the IP address of the VPN server in the field next to the checkbox.

4.7.2 PPTP Remote Dial-in

You can manage remote access by maintaining a table of remote user profile, so that users can be authenticated to dial-in via VPN connection.

The router provides access accounts for dial-in users.

Users

Username	Full Name	Allow Disk Sharing	Allow IPSEC/L2TP	Allow PPTP	Allow FTP
No users defined					

Add a New User

Adding a New User

Click **Add new user** to open the following page.

User Configuration

Add User

User Settings	
Username	<input type="text" value="carrie"/>
Full Name	<input type="text" value="carrie ni"/>
Password	<input type="password" value="••••••"/>
Confirm Password	<input type="password" value="••••••"/>
Allow Disk Sharing	<input checked="" type="checkbox"/>
Allow IPSEC/L2TP	<input checked="" type="checkbox"/>
Allow PPTP	<input checked="" type="checkbox"/>
Allow FTP	<input checked="" type="checkbox"/>

Username	Type a name for this user.
Full Name	Type full name for this user.
Password	Type the password for this user.
Password (again)	Type the password again for confirmation.
Allow Disk Sharing	Check this box to have the remote user share the disk information.
Allow IPSEC/L2TP	Check this box to let the remote user connecting to this device through IPSEC/L2TP.
Allow PPTP	Check this box to let the remote user connecting to this device through PPTP.
Allow FTP	Check this box to let the remote user connecting to FTP server via this router.
Delete User	Remove settings on current page and delete the user. This button is not available for new configuration by pressing Add a New User .

When you finish the settings, simply click **OK** to save the configuration. The new user will be created and displayed on the page.

Users

Users					
Username	Full Name	Allow Disk Sharing	Allow IPSEC/L2TP	Allow PPTP	Allow FTP
carrie	carrie ni	✓	✓	✓	✓

Editing/Deleting User Settings

To edit a user, click the name link under Username to open the following page. Modify the settings except Username and then click **OK** to save and exit it. If you want to remove such user settings, simply click **Delete User**.

User Configuration

Edit User

User Settings

Username	<input type="text" value="carrie"/>
Full Name	<input type="text" value="carrie ni"/>
Password	<input type="password" value="••••••"/>
Confirm Password	<input type="password" value="••••••"/>
Allow Disk Sharing	<input checked="" type="checkbox"/>
Allow IPSEC/L2TP	<input checked="" type="checkbox"/>
Allow PPTP	<input checked="" type="checkbox"/>
Allow FTP	<input checked="" type="checkbox"/>

4.7.3 IPSec Remote Dial-in

This page allows you to configure IPSec Site-to-Client settings.

VPN and Remote Access >> Remote Dial-in Setup

IPSec Site-to-Client (Mobile VPN)

Mobile VPN Type

Mobile VPN Type	<input type="text" value="Disabled"/>
-----------------	---------------------------------------

Authentication

Shared secret	<input type="text"/>
Shared secret (again)	<input type="text"/>

Advanced Security Settings

Phase 1 (IKE)	<input type="text" value="Automatic"/> (sha1/md5;group2/group5)
Phase 2 (IPSec)	<input type="text" value="Automatic"/> (sha1/md5)

Mobile VPN Type

This usually applies to those are remote dial-in user or node (LAN-to-LAN) which uses dynamic IP address and

IPSec-related VPN connections such as L2TP over IPSec and IPSec tunnel.

Disabled – Ignore the configurations set in this page.

Dynamic VPN (IPSec) – Traffic between this subnet and the client will travel through the VPN tunnel. If you choose this type, please specify the IP address and subnet mask for local network.

Mobile VPN Type

Mobile VPN Type	Dynamic VPN (IPsec) ▼
Local Network / Mask	0.0.0.0 / 0.0.0.0

L2TP/IPSec –The range must not overlap the DHCP address range (if enabled), and must allow for at least one IP address. Example: 10.10.137.240-10.10.137.245. If you choose this type, please specify the IP address range for L2TP/IPSec mode.

IPSec Site-to-Client (Mobile VPN)

Mobile VPN Type

Mobile VPN Type	L2TP/IPsec ▼
L2TP IP Address range	<input type="text"/>
Remote Dial-in User	Add User

(DHCP Range: 192.168.1.10-192.168.1.60)

Authentication

Shared secret – Type the shared secret manually and confirm it again. IPSec remote dial-in clients will use the given secret.

Advanced Settings

Phase 1 (IKE) - Negotiation of IKE parameters including encryption, hash, Diffie-Hellman parameter values, and lifetime to protect the following IKE exchange, authentication of both peers using either a Pre-Shared Key or Digital Signature (x.509). The peer that starts the negotiation proposes all its policies to the remote peer and then remote peer tries to find a highest-priority match with its policies.

Phase 2 (IPSec) - Negotiation IPSec security methods including Authentication Header (AH) or Encapsulating Security Payload (ESP) for the following IKE exchange and

mutual examination of the secure tunnel establishment.

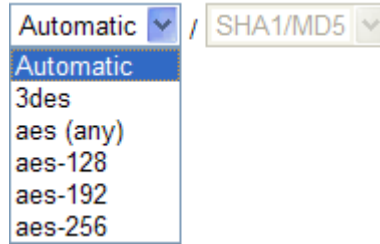

4.7.4 Remote Dial-in Status

You can find the summary table of all dial-in user status.

[VPN and Remote Access >> Remote Dial-in Status](#)

Auto-refresh

IPSec Site-to-Client Status

Client	Identity	Endpoint	IKE Status	IKE Alg	ESP Status	ESP Alg
<i>No IPSec/Mobile Clients</i>						

PPTP Site-to-Client Status

User Name	Interface	Remote IP	Login Time	Rx bytes	Tx bytes
<i>No PPTP Clients</i>					

- Client** Display the name of the VPN IPSec/Mobile client.
- Identity** Display the remote ID of the VPN client.
- Endpoint** Display the IP address of the VPN client.
- IKE Status** Display the status of the phase 1 ISAKMP key exchange.
- IKE Alg** Display the encryption and authentication algorithm used during phase 1 of the VPN connection Establishment. The algorithm is used during exchange of key exchange.
- ESP Status** Display the status of the phase 2 IPSec ESP key exchange.
- ESP Alg** Display the encryption and authentication algorithm used during phase 2 of the VPN connection Establishment. This algorithm is used for transporting data, and the choice will affect the performance of the VPN tunnel.
- User Name** Display the dial-in user account.
- Interface** Display the connection name assigned by the router.
- Remote IP** Display IP address of remote client.
- Login Time** Display the system time that the user logs in.
- Rx bytes** Display the data total received for such client.
- Tx bytes** Display the data total transmitted for such client.
- Auto-refresh** Check this box to make the system refresh this page automatically.
- Refresh** Click this button to refresh the page immediately.

4.7.5 LAN to LAN

Here you can manage LAN-to-LAN connections by maintaining a table of connection profiles. You may set parameters including specified connection direction (dial-in or dial-out), connection peer ID, connection type (VPN connection - including PPTP, IPsec Tunnel) and corresponding security methods, etc.

The router supports 2 VPN tunnels simultaneously and provides up to 2 profiles. The following figure shows the summary table.

VPN and Remote Access >> LAN to LAN

VPN Site-to-Site Tunnels (IPSec)

Auto-refresh

Name	Endpoint	IKE		ESP	
		Status	Alg	Status	Alg
No VPN tunnels					

Name	Indicate the name of the LAN-to-LAN profile.
Endpoint	Display the IP address of the VPN client.
IKE Status	Display the status of the phase 1 ISAKMP key exchange.
IKE Alg	Display the encryption and authentication algorithm used during phase 1 of the VPN connection Establishment. The algorithm is used during exchange of key exchange.
ESP Status	Display the status of the phase 2 IPsec ESP key exchange.
ESP Alg	Display the encryption and authentication algorithm used during phase 2 of the VPN connection Establishment. This algorithm is used for transporting data, and the choice will affect the performance of the VPN tunnel.

Adding a VPN Tunnel

Click **Add Tunnel** to open the following page.

VPN and Remote Access >> LAN-to-LAN

Add VPN Tunnel

General

Enabled	<input checked="" type="checkbox"/>
Always On	<input checked="" type="checkbox"/>
Name	<input type="text"/>
Remote IP	<input type="text"/>
IKE phase 1 mode	Main Mode <input type="button" value="v"/>

Authentication

Pre-Shared Key	<input type="text"/>
Confirm Pre-Shared Key	<input type="text"/>
Local Identity	<input type="text"/>
Remote Identity	<input type="text"/>

Networks

Local Network / Mask	<input type="text"/> / <input type="text"/>
Remote Network / Mask	<input type="text"/> / <input type="text"/>

Advanced Security Settings

IKE phase 1 proposal <small>*note</small>	Automatic <input type="button" value="v"/> (sha1/md5_group2/group5)
IKE phase 2 proposal	Automatic <input type="button" value="v"/> (sha1/md5)
Perfect Forward Secrecy	<input type="checkbox"/>

Enabled

Check here to activate this tunnel.

Always On

Check this box to make the WAN connection being activated always.

Name

Specify a name for this tunnel.

Remote IP

Enter the IP address of the remote host that located at the other-end of the VPN tunnel.

IKE phase 1 mode

Select from **Main** mode and **Aggressive** mode. The ultimate outcome is to exchange security proposals to create a protected secure channel. **Main** mode is more secure than **Aggressive** mode since more exchanges are done in a secure channel to set up the IPSec session. However, the **Aggressive** mode is faster. The default value in Vigor router is Main mode.

IKE phase 1 mode

Main Mode <input type="button" value="v"/>
Main Mode
Aggressive Mode

Pre-Shared Key

Such field will be applicable when Pre-shared key is selected as the Type for the authentication. Input 1-63 characters as pre-shared key.

- Confirm Pre-Shared key** Such field will be applicable when Pre-shared key is selected as the Type for the authentication. Input 1-63 characters as pre-shared key again to confirm it.
- Local Identity** Local Identity is on behalf of the IP address while identity authenticating with remote VPN server. The length of the ID is limited to 47 characters.
- Remote Identity** This field defines the identity of the remote end.
- Local Network / Mask** Traffic between this subnet and the subnet specified in Remote Network / Mask will travel through the VPN tunnel.
- Remote Network / Mask** Add a static route to direct all traffic destined to this Remote Network IP Address/Remote Network Mask through the VPN connection. For IPSec, this is the destination clients IDs of phase 2 quick mode.
- IKE Phase 1 proposal** Propose the local available authentication schemes and encryption algorithms to the VPN peers, and get its feedback to find a match.

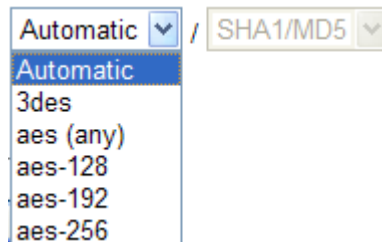

- IKE Phase 2 proposal** Propose the local available algorithms to the VPN peers, and get its feedback to find a match.

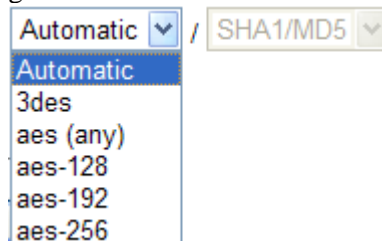

- Perfect Forward Secrecy** The IKE Phase 1 key will be reused to avoid the computation complexity in phase 2. The default value is inactive this function.

4.8 Wireless LAN

This function is used for “n” models.

4.8.1 Basic Concepts

Over recent years, the market for wireless communications has enjoyed tremendous growth. Wireless technology now reaches or is capable of reaching virtually every location on the surface of the earth. Hundreds of millions of people exchange information every day via wireless communication products. The Vigor “n” model, a.k.a. Vigor wireless router, is designed for maximum flexibility and efficiency of a small office/home. Any authorized staff can bring a built-in WLAN client PDA or notebook into a meeting room for conference without laying a clot of LAN cable or drilling holes everywhere. Wireless LAN enables high mobility so WLAN users can simultaneously access all LAN facilities just like on a wired LAN as well as Internet access

The Vigor wireless routers are equipped with a wireless LAN interface compliant with the standard IEEE 802.11n draft 2 protocol. To boost its performance further, the Vigor Router is also loaded with advanced wireless technology to lift up data rate up to 300 Mbps*. Hence, you can finally smoothly enjoy stream music and video.

Note: * The actual data throughput will vary according to the network conditions and environmental factors, including volume of network traffic, network overhead and building materials.

In an Infrastructure Mode of wireless network, Vigor wireless router plays a role as an Access Point (AP) connecting to lots of wireless clients or Stations (STA). All the STAs will share the same Internet connection via Vigor wireless router. The **General Settings** will set up the information of this wireless network, including its SSID as identification, located channel etc.

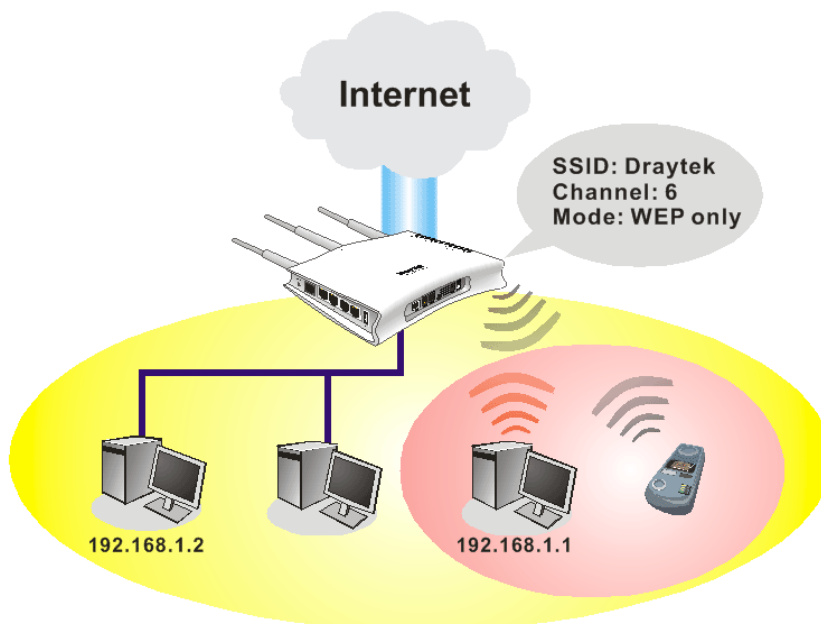

Security Overview

Real-time Hardware Encryption: Vigor Router is equipped with a hardware AES encryption engine so it can apply the highest protection to your data without influencing user experience.

Complete Security Standard Selection: To ensure the security and privacy of your wireless communication, we provide several prevailing standards on market.

WEP (Wired Equivalent Privacy) is a legacy method to encrypt each frame transmitted via radio using either a 64-bit or 128-bit key. Usually access point will preset a set of four keys and it will communicate with each station using only one out of the four keys.

WPA (Wi-Fi Protected Access), the most dominating security mechanism in industry, is separated into two categories: WPA-personal or called WPA Pre-Share Key (WPA/PSK), and WPA-Enterprise or called WPA/802.1x.

In WPA-Personal, a pre-defined key is used for encryption during data transmission. WPA applies Temporal Key Integrity Protocol (TKIP) for data encryption while WPA2 applies AES. The WPA-Enterprise combines not only encryption but also authentication.

Since WEP has been proved vulnerable, you may consider using WPA for the most secure connection. You should select the appropriate security mechanism according to your needs. No matter which security suite you select, they all will enhance the over-the-air data protection and /or privacy on your wireless network. The Vigor wireless router is very flexible and can support multiple secure connections with both WEP and WPA at the same time.

Below shows the menu items for Wireless LAN.

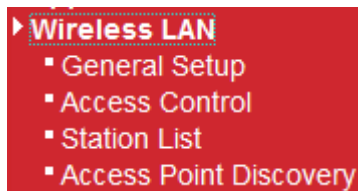

4.8.2 General Setup

By clicking the **General Setup**, a new web page will appear so that you could configure the SSID and the wireless channel.

Please refer to the following figure for more information.

Wireless LAN >> General Setup

General Setting

Enable Wireless LAN	<input checked="" type="checkbox"/>	Show/Hide	SSID	Isolate
SSID 1	<input checked="" type="checkbox"/>	Show	DrayTek	<input type="checkbox"/>
SSID 2	<input type="checkbox"/>	Show	DrayTek2	<input type="checkbox"/>
SSID 3	<input type="checkbox"/>	Show	DrayTek3	<input type="checkbox"/>
SSID 4	<input type="checkbox"/>	Show	DrayTek4	<input type="checkbox"/>
Wireless Mode	Mixed (11b+11g+11n)			
Channel	Channel 11, 2462MHz			
Tx Power	100%			
Enable Green AP	<input type="checkbox"/>			

Isolate: Wireless clients (stations) with the same SSID cannot access for each other.



Wireless Security Configuration

Encryption	None
------------	------

OK

Enable Wireless LAN

Check the box to enable the wireless function.

- SSID Broadcast** Choose **Show** to make the SSID being seen by wireless clients. Choose **Hide** to prevent from wireless sniffing and make it harder for unauthorized clients or STAs to join your wireless LAN.
- SSID** It means the identification of the wireless LAN. SSID can be any text numbers or various special characters. The default SSID is "DrayTek". We suggest you to change it.
- Isolate** Check this box to make the wireless clients (stations) with the same SSID not accessing for each other.
- Wireless Mode** Choose the wireless mode for this router. At present, only 802.11B/B/N mix is available.
- Country Region Code** It represents different country region code. Use the drop down list to choose the one that fit the usage of regulations locally.
- Channel** It means the channel of frequency of the wireless LAN. The default channel is 11. You may switch channel if the selected channel is under serious interference. If you have no idea of choosing the frequency, please select **Auto** to let system determine for you.
- Tx Power** Set the power percentage for transmission signal of access point. The greater the value is, the higher intensity of the signal will be.

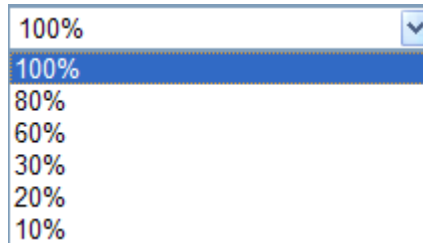

- Enable Green AP** Such function is used to reduce the power consumption (Green AP) for the access point. When there is no station connected, the power consumption of access point will be reduced.
- Encryption** Select an appropriate encryption mode to improve the security and privacy of your wireless data packets.

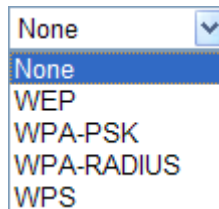

Each encryption mode will bring out different web page and ask you to offer additional configuration.

Wireless Security Configuration

For the security of your system, choose the proper encryption for data transmission. Different encryption mode will bring out different setting encryption ways.

Wireless Security Configuration

Encryption	None
------------	------

None
WEP
WPA-PSK
WPA-RADIUS
WPS

OK

- **None**

The encryption mechanism is turned off.

- **WEP**

Accepts only WEP clients and the encryption key should be entered in WEP Key.

Wireless Security Configuration

Encryption	WEP
------------	-----

WEP Configuration

Default Key	Key1
Key1	
Key2	
Key3	
Key4	
Authentication Mode	OPEN

OK Cancel

Default Key

All wireless devices must support the same WEP encryption bit size and have the same key.

Key1-Key4

Four keys can be entered here, but only one key can be selected at a time. The format of WEP Key is restricted to 5 ASCII characters or 10 hexadecimal values in 64-bit encryption level, or restricted to 13 ASCII characters or 26 hexadecimal values in 128-bit encryption level. The allowed content is the ASCII characters from 33(!) to 126(~) except '#' and ','.

Authentication Mode

Choose OPEN or SHARED as the authentication mode.
OPEN: Set wireless to authentication open mode.
SHARED: Set wireless to authentication shared mode.

- **WPA-PSK**

Accepts only WPA clients and the encryption key should be entered in PSK. The WPA encrypts each frame transmitted from the radio using the key, which either PSK (Pre-Shared Key) entered manually in this field below or automatically negotiated via 802.1x authentication.

Wireless Security Configuration

Encryption	WPA-PSK
------------	---------

WPA-PSK Configuration

Type	WPA
WPA Algorithm	TKIP
WPA Pre-Shared Key	

OK Cancel

WPA Mode

Select WPA, WPA2 or Auto as the type.

WPA
WPA
WPA2
Auto(WPA or WPA2)

WPA Algorithm

Select TKIP, AES or auto as the algorithm for WPA.

TKIP
TKIP
AES
Auto(TKIP or AES)

WPA Pre-Shared Key

Either 8~63 ASCII characters, such as 012345678..(or 64 Hexadecimal digits leading by 0x, such as "0x321253abcde...").

● WPA-RADIUS

The built-in RADIUS client feature enables the router to assist the remote dial-in user or a wireless station and the RADIUS server in performing mutual authentication. It enables centralized remote access authentication for network management.

Wireless Security Configuration

Encryption	WPA-RADIUS
------------	------------

WPA-RADIUS Configuration

Type	WPA
WPA Algorithm	TKIP
Server IP Address	0.0.0.0
Destination Port	1812
Shared Secret	radius_secret

OK Cancel

Type

The WPA encrypts each frame transmitted from the radio using the key, which either PSK (Pre-Shared Key) entered manually in this field below or automatically negotiated via 802.1x authentication. Select WPA, WPA2 or Auto as WPA mode.

Auto(WPA or WPA2)
WPA
WPA2
Auto(WPA or WPA2)

WPA Algorithm

Choose the WPA algorithm, TKIP, AES or Auto.

Server IP Address

Enter the IP address of RADIUS server.

Destination Port

The UDP port number that the RADIUS server is using. The default value is 1812, based on RFC 2138.

Shared Secret

The RADIUS server and client share a secret that is used to authenticate the messages sent between them. Both sides must be configured to use the same shared secret.

- **WPS**

WPS (Wi-Fi Protected Setup) provides easy procedure to make network connection between wireless station and wireless access point (vigor router) with the encryption of WPA and WPA2.

Wireless Security Configuration
WPS Configuration
Configure via Push Button

Click **Start PBC** to invoke Push-Button style WPS setup procedure. The router will wait for WPS requests from wireless clients about two minutes. The WPS LED on the router will blink fast when WPS is in progress. It will return to normal condition after two minutes. (You need to setup WPS within two minutes)

Configure via Client PinCode

Type the PIN code specified in wireless client you wish to connect, and click **Start PIN** button. The WLAN LED on the router will blink fast when WPS is in progress. It will return to normal condition after two minutes. (You need to setup WPS within two minutes).

It is the simplest way to build connection between wireless network clients and vigor router. Users do not need to select any encryption mode and type any long encryption passphrase to setup a wireless client every time. He/she only needs to press a button on wireless client, and WPS will connect for client and router automatically.

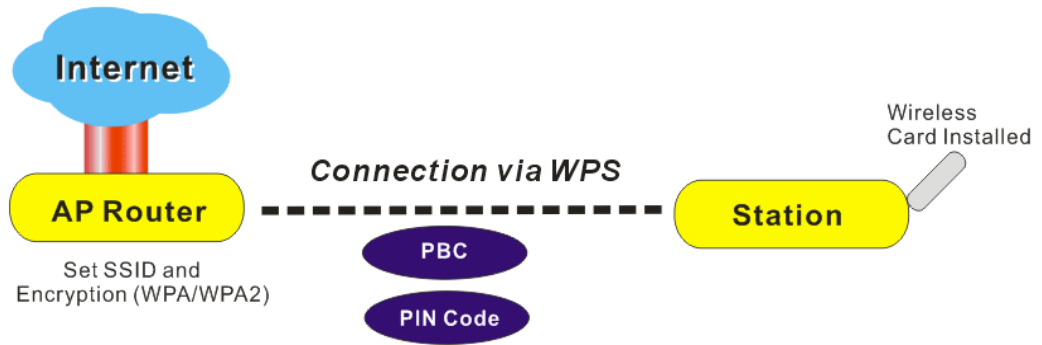

Note: Such function is available for the wireless station with WPS supported.

There are two methods to do network connection through WPS between AP and Stations: pressing the **Start PBC** button or using **PIN Code**.

On the side of Vigor 2130 series which served as an AP, press **WPS** button once on the front panel of the router or click **Start PBC** on web configuration interface. On the side of a station with network card installed, press **Start PBC** button of network card.

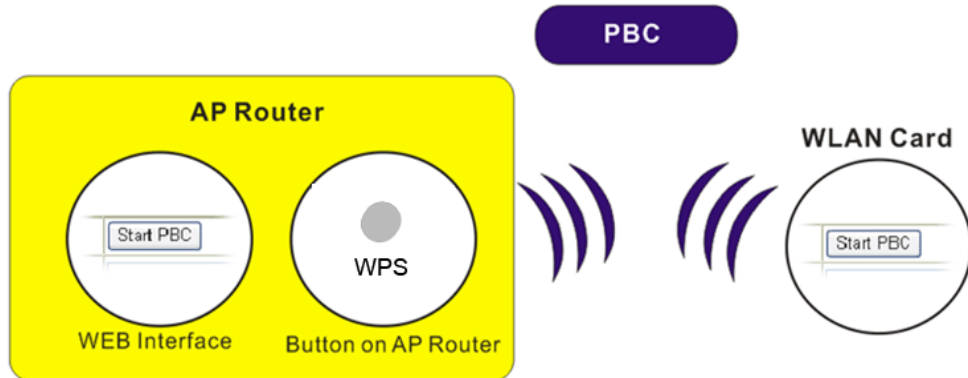

If you want to use PIN code, you have to know the PIN code specified in wireless client. Then provide the PIN code of the wireless client you wish to connect to the vigor router.

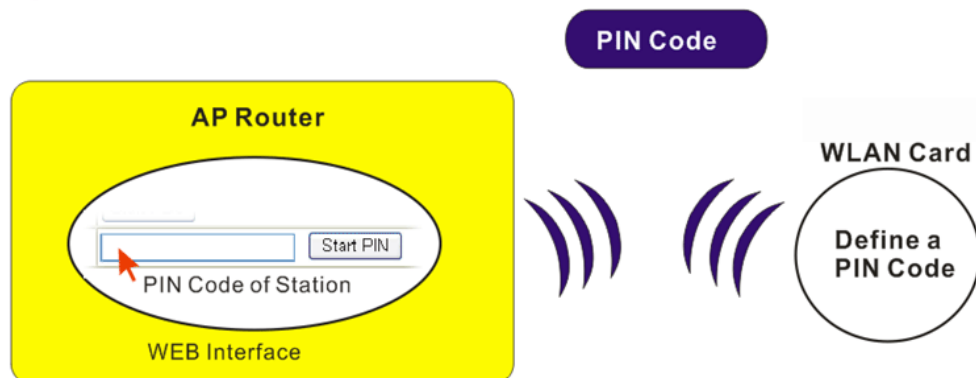

4.8.3 Access Control

For additional security of wireless access, the **Access Control** facility allows you to restrict the network access right by controlling the wireless LAN MAC address of client. Only the valid MAC address that has been configured can access the wireless LAN interface. By clicking the **Access Control**, a new web page will appear, as depicted below, so that you could edit the clients' MAC addresses to control their access rights (deny or allow).

Wireless LAN >> Access Control

Wireless MAC Address Filter Configuration

SSID 1	SSID 2	SSID 3	SSID 4
Filter Type			Deny List <input type="button" value="v"/>

Delete	MAC Address
--------	-------------

Note: Each SSID up to 64 MAC address at one time.

Filter Type

Choose the rule for the MAC addresses displayed in this page.

Allow List – all the MAC address of wireless clients listed here are allowed to do wireless connection.

Deny List – all the MAC address of wireless clients listed here will be blocked.

Add a New Entry

Add a new MAC address into the list.

Delete

Delete the selected MAC address in the list. This button will appear only an entry of MAC Address has been typed.

Delete	MAC Address
<input type="button" value="Delete"/>	<input type="text" value="00:20:00:05:30:12"/>
<input type="button" value="Add a New Entry"/>	

Cancel

Give up the configuration.

OK

Click it to save the configuration.

4.8.4 Station List

Station List provides the knowledge of connecting wireless clients now along with its status code.

Wireless LAN >> Station List

Station List

Auto-refresh

Index	IP Address	MAC Address	Connected Time
No Station			

Index	Display the number of the connecting client.
IP Address	Display the WAN IP address for the connecting client.
MAC Address	Display the MAC Address for the connecting client.
Connected Time	Display the connection time for the connecting client.
Auto-refresh	Check this box to force the system refreshing the table automatically.
Refresh	Click this button to refresh current page.

4.8.5 Access Point Discovery

Vigor router can scan all regulatory channels and find working APs in the neighborhood. Based on the scanning result, users will know which channel is clean for usage.

Note: During the scanning process (about 5 seconds), no client is allowed to connect to Vigor.

The table will list channel, SSID, BSSID, Security and the Signal strength of working APs in the neighborhood.

Wireless LAN >> Access Point Discovery

Access Point Discovery

CH	SSID	BSSID	Security	Signal(%)
<input type="button" value="Scan"/>				

Note: During the scanning process (~5 seconds), no station is allowed to connect with the router.

CH	Display the channel for the scanned AP.
SSID	Display the SSID of the scanned AP.
BSSID	Display the MAC address of the scanned AP.
Security	Display the encryption type of the scanned AP.
Signal	Display the strength (in percentage) of the signal of the scanned AP.
Scan	It is used to discover all the connected AP. The results will be shown on the box above this button.

4.9 USB Application

USB diskette can be regarded as an FTP server. By way of Vigor router, clients on LAN can access, write and read data stored in USB diskette. After setting the configuration in **USB Application**, you can type the IP address of the Vigor router and username/password created in **USB Application>>FTP User Setting** on the FTP client software. Thus, the client can use the FTP site (USB diskette) through Vigor router.

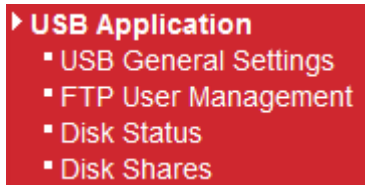

4.9.1 USB General Settings

This page will determine the number of concurrent FTP connection and default charset for FTP server. At present, the Vigor router can support USB diskette with versions of FAT16 and FAT32 only. Therefore, before connecting the USB diskette into the Vigor router, please make sure the memory format for the USB diskette is FAT16 or FAT32. It is recommended for you to use FAT32 for viewing the filename completely (FAT16 cannot support long filename).

USB Application >> USB General Settings

USB General Settings

Enable FTP	<input type="checkbox"/>
Enable Disk Sharing	<input type="checkbox"/>
Workgroup Name	<input type="text" value="WORKGROUP"/>

Enable FTP

Check this box to enable FTP connection.

Enable Disk Sharing

Check this box to share the information on USB disk.

Workgroup Name

Type the name for FTP users for accessing into FTP server (USB diskette). Be aware that users cannot access into USB diskette in anonymity. Later, you can open FTP client software and type the username specified here for accessing into USB storage diskette.

4.9.2 FTP User Management

This page allows you to change user setting for USB storage disk. Before modifying settings in this page, please insert a USB diskette and configure settings in **User>>User Configuration** first. Otherwise, an error message will appear to warn you.

USB Application >> FTP User Management

FTP User Management

User Name	Volume	Path	Access Rights
carrie	--	--	Read-only

Click the name link under User Name to open the setting web page.

USB Application >> FTP User Setting

FTP User Configuration

User Name	carrie
Volume	USB2.0 - Mobile Disk (1) - 1967M - PORT 1 ▾
Home Folder	/
Access Rule	Read-only ▾

OK Cancel

- User Name** It displays the username that user uses to login to the FTP server.
- Volume** Select the proper volume for the connected USB diskette.
- Home Folder** It determines the range for the client to access into. The user can enter a directory name in this field. Then, after clicking **OK**, the router will create the specific/new folder in the USB diskette. In addition, if the user types “/” here, he/she can access into all of the disk folders and files in USB diskette. **Note:** When write protect status for the USB diskette is **ON**, you cannot type any new folder name in this field. Only “/” can be used in such case.

Access Rule Select the access right for the USB diskette.

Read-only ▾
Read-only
Read-write

When you finish the settings, simply click **OK** to save the configuration.

4.9.3 Disk Status

This page can display current using status of the USB diskette. If you want to remove the diskette from USB port in router, please check the box of Safely Remove Disk first. And then, remove the USB diskette later.

USB Application >> Disk Status

Disk Status

Safely Remove Disk	Manufacturer	Model	Size	Free Capacity	Status
<input type="checkbox"/>	Generic	Flash Disk	2011M	1.6G	In use

Update

- Safely Remove Disk** Check this box and then you can remove the USB diskette safely.
- Manufacturer** Display the manufacturer of the disk.
- Model** Display the type of the disk.
- Size** Display the storage space of the diskette(s).
- Free Capacity** Display the free disk space of the diskette(s).
- Status** Display current usage status of the diskette(s)

Update

Click this button to refresh the disk status.

4.9.4 Disk Shares

This page can define the folder which will be shared while Samba File Sharing is enabled.

USB Application >> Disk Shares

Share Name	Comment	Path	Visible
No Shares			

To add a new entry for disk sharing, please click **Add a New Entry** to open the following page.

USB Application >> Disk Share

Add Disk Share

Identification

Share Name	<input type="text"/>
Comment	<input type="text"/>

Settings

Volume	USB2.0 - Mobile Disk (1) - 1967M - PORT 1 <input type="button" value="v"/>
Path	<input type="text" value="/"/>
Visible	<input type="checkbox"/>

Access Rights

Access	All Users Read-only <input type="button" value="v"/>
--------	--

- Share Name** Type a name to be known by other computers in local network. The name must not contain spaces or special characters.
- Comment** Type the brief description for the disk sharing. The words here will be seen in Network Neighborhood on Windows client computers
- Volume** Select the proper volume for the connected USB diskette.
- Path** It determines the range for the client to access into. The user can enter a directory name in this field. Then, after clicking **OK**, the router will create the specific/new folder in the USB diskette. In addition, if the user types "/" here, he/she can access into all of the disk folders and files in USB diskette. **Note:** When write protect status for the USB diskette is **ON**, you cannot type any new folder name in this field. Only "/" can be used in such case.
- Visible** Check this box to make this USB diskette to be seen in Network Neighborhood on Windows of clients in local network.
- Access Rights** Specify the access right and apply to all the wireless clients that want to connect to the attached USB diskette.

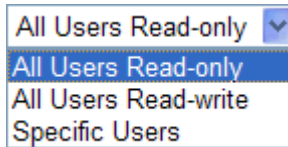

All Users Read-only - everyone has read-only access to the share disk.

All Users Read-write - everyone has read-write access to the share disk.

Specific Users – Only specific user(s) can access into the share disk.

4.10 IPv6



4.10.1 IPv6 WAN Setup

This page defines the IPv6 connection types for WAN interface. Possible types contain Link-Local only, Static IPv6, DHCPv6 and TSPC. Each type requires different parameter settings.

IPv6 >> WAN General Setup

WAN IPv6 Configuration

IPv6 Connection Type	Link-Local Only
----------------------	-----------------

Link-Local Only

IPv6 Address	fe80::250:ff:fe00:2
Prefix Length	64

OK

WAN IPv6 Configuration

IPv6 Connection Type	Link-Local Only
	<ul style="list-style-type: none"> Link-Local Only Static IPv6 DHCPv6 Client (IA_NA) TSPC DHCPv6 Client (IA_PD)
Link-Local Only	
IPv6 Address	
Prefix Length	

Link-Local Only

Link-Local address is used for communicating with neighbouring nodes on the same link. It is defined by the address prefix **fe80::/10**. You don't need to setup Link-Local address manually for it is generated automatically according to your MAC Address.

IPv6 >> WAN General Setup

WAN IPv6 Configuration

IPv6 Connection Type	Link-Local Only ▾
----------------------	-------------------

Link-Local Only

IPv6 Address	fe80::250:7fff:fe38:60ca
Prefix Length	64

OK

IPv6 Address The least significant 64 bits are usually chosen as the interface hardware address constructed in modified EUI-64 format.

Prefix Length Display the fixed value (64) for prefix length.

Static IPv6

This type allows you to setup static IPv6 address for WAN.

IPv6 >> WAN General Setup

WAN IPv6 Configuration

IPv6 Connection Type	Static IPv6 ▾
----------------------	---------------

Static IPv6

IPv6 Address	<input type="text"/>
Prefix Length	<input type="text" value="0"/>
Gateway IPv6 Address	<input type="text"/>
Primary DNS Server	<input type="text"/>
Secondary DNS Server	<input type="text"/>

OK

IPv6 Address Type your IPv6 static IP here.

Prefix Length Type your IPv6 address prefix length here.

Gateway IPv6 Server Type your IPv6 gateway address here.

Primary DNS Server Type your IPv6 primary DNS Server address here.

Secondary DNS Server Type your IPv6 secondary DNS Server address here.

DHCPv6 Client (IA_NA)

DHCPv6 client mode would use IA_NA option of DHCPv6 protocol to obtain IPv6 address from server.

IPv6 >> WAN General Setup

WAN IPv6 Configuration

IPv6 Connection Type DHCPv6 Client (IA_NA) ▾

DHCPv6

User defined DNS server

Primary DNS Server

Secondary DNS Server

OK

Primary DNS Server

Type primary DNS Server address here.

Secondary DNS Server

Type secondary DNS Server address here

DHCPv6 Client (IA_PD)

DHCPv6 client mode would use IA_PA option of DHCPv6 protocol to obtain IPv6 prefix from server.

IPv6 >> WAN General Setup

WAN IPv6 Configuration

IPv6 Connection Type DHCPv6 Client (IA_PD) ▾

OK

TSPC

Tunnel setup protocol client (TSPC) is an application which could help you to connect to IPv6 network easily.

Please make sure your IPv4 WAN connection is OK and apply one free account from hexage (<http://go6.net/4105/register.asp>) before you try to use TSPC for network connection. TSPC would connect to tunnel broker and requests a tunnel according to the specifications inside the configuration file. It gets a public IPv6 IP address and an IPv6 prefix from the tunnel broker and then monitors the state of the tunnel in background.

After getting the IPv6 prefix and starting router advertisement daemon (RADVD), the PC behind this router can directly connect to IPv6 the Internet.

IPv6 >> WAN General Setup

WAN IPv6 Configuration

IPv6 Connection Type	TSPC
----------------------	------

TSPC

User Name :	vigor2130
Password :	●●●●●●●●
Confirm Password :	
Tunnel Broker :	broker.freenet6.net
Tunnel mode :	IPv6-in-IPv4 Tunnel
Auto-reconnect Delay :	30
Keepalive :	<input checked="" type="radio"/> Yes <input type="radio"/> No
keepalive_interval :	30
Prefixlen :	56
If_prefix :	br-lan

OK

Username Type the name obtained from the broker. “vigor2130” is a default username applied from <http://go6.net/4105/register.asp>. It is suggested for you to apply another username and password.

Password Type the password assigned with the user name.

Confirm Password Type the password again to make the confirmation.

Tunnel Broker Type the address for the tunnel broker IP, FQDN or an optional port number.

Tunnel Mode **IPv6-in-IPv4 Tunnel**- Let the broker choose the tunnel mode appropriate for the client.

IPv6-in-IPv4 (Native) - Request an IPv6 in IPv4 tunnel.

IPv6-in-IPv4 (NAT Traversal) - Request an IPv6 in UDP of IPv4 tunnel (for clients behind a NAT).

IPv6-in-IPv4 (NAT Traversal)
IPv6-in-IPv4 Tunnel
IPv6-in-IPv4 (Native)
IPv6-in-IPv4 (NAT Traversal)

Auto-reconnect Delay After passing the time set here, the client will retry to connect in case of failure or keepalive timeout. 0 means not retry.

Keepalive **Yes** – Keep the connection between TSPC and tunnel broker always on. TSPC will send ping packet to make sure the connection between both ends is normal.
No - The client will not send keepalives.

Keepalive_interval Type the time for the interval between two keepalive messages transferring from the client to the broker.

Prefixlen	Type the required prefix length for the client network.
If_prefix	Display LAN interface name. The name of the OS interface that will be configured with the first 64 of the received prefix from the broker and the router advertisement daemon is started to advertise that prefix on the if_prefix interface.

4.10.2 IPv6 LAN Setup

This page defines the IPv6 connection types for LAN interface. Possible types contain DHCPv6 Server and RADVD. Each type requires different parameter settings.

IPv6 >> LAN General Setup

LAN IPv6 Configuration

IPv6 Address	<input type="text" value="2000::1"/>	/64
IPv6 Link_local Address	<input type="text" value="fe80::200:ff:fe00:0"/>	

IPv6 Address Autoconfiguration

<input checked="" type="checkbox"/> Enable Autoconfiguration
Configuration Type <input type="text" value="DHCPv6 Server"/>

DHCPv6 (Stateful)

IPv6 Start Address	<input type="text" value="2000:0:0:0::10"/>	/64
IPv6 End Address	<input type="text" value="2000:0:0:0::FF"/>	/64

OK

IPv6 Address	Type static IPv6 address for LAN.
IPv6 Link_local Address	It is used for communicating with neighbouring nodes on the same link. It is defined by the address prefix fe80::/10. You don't need to setup Link-Local address manually for it is generated automatically according to your MAC Address.
Enable Autoconfiguration	Check this box to enable the auto-configuration function for IPv6 connection.
Configuration Type	Vigor2130 provides 2 daemons for LAN side IPv6 address configuration. One is RADVD (stateless) and the other is DHCPv6 Server (Stateful). DHCPv6 Server - DHCPv6 Server could assign IPv6 address to PC according to the Start/End IPv6 address configuration.

DHCPv6 (Stateful)

IPv6 Start Address	2000:0:0:0:	<input type="text"/>	/64
IPv6 End Address	2000:0:0:0:	<input type="text"/>	/64

OK

IPv6 Start Address/IPv6 End Address- Type the start and end address for IPv6 server.

RADVD - The router advertisement daemon (radvd) sends Router Advertisement messages, specified by RFC 2461, to a local Ethernet LAN periodically and when requested by a node sending a Router Solicitation message. These messages are required for IPv6 stateless autoconfiguration.

RADVD (Stateless)

Advertisement lifetime	<input type="text" value="30"/>	(minutes)
------------------------	---------------------------------	-----------

OK

Advertisement Lifetime - The lifetime associated with the default router in units of seconds. It's used to control the lifetime of the prefix. The maximum value corresponds to 18.2 hours. A lifetime of 0 indicates that the router is not a default router and should not appear on the default router list.

4.10.3 IPv6 Firewall Setup

This page allows users to set firewall rules for IPv6 packets.

Note: Section 4.4 **Firewall** is configured for IPv4 packets only.

IPv6 >> IPv6 Firewall

IPv6 Firewall List

Name	Protocol	Source IP	Destination IP	Source Port	Destination Port	Action
------	----------	-----------	----------------	-------------	------------------	--------

Name	Display the name of the rule.
Protocol	Display the protocol (TCP/UDP/ICMPv6) the rule uses.
Source IP	Display the source IP address of such rule.
Destination IP	Display the destination IP address of such rule.
Source Port	Display the source port number of such rule.
Destination Port	Display the destination port number of such rule.
Action	Display the status (accept or drop) of such rule.

Adding a New Rule

Click **Add New Rule** to configure a new rule for IPv6 Firewall.

Note: You can set up to 20 sets of IPv6 rules.

[IPv6 >> IPv6 Firewall Setup](#)

Add IPv6 Firewall Rule

Name	<input type="text"/>
Protocol	ALL <input type="button" value="v"/>
Source IP Type	None <input type="button" value="v"/>
Source IP	<input type="text"/>
Source Subnet	<input type="text"/> / <input type="text" value="64"/>
Destination IP Type	None <input type="button" value="v"/>
Destination IP	<input type="text"/>
Destination Subnet	<input type="text"/> / <input type="text" value="64"/>
Source Start Port	<input type="text"/>
Source End Port (optional)	<input type="text"/>
Destination Start Port	<input type="text"/>
Destination End Port (optional)	<input type="text"/>
Action	ACCEPT <input type="button" value="v"/>

OK

Cancel

Name

Type a name for the rule.

Protocol

Specify a protocol for this rule.

ALL <input type="button" value="v"/>
ALL
TCP
UDP
ICMPv6

Source IP Type

Determine the IP type as the source.

None <input type="button" value="v"/>
None
Single
Subnet

Source IP

Type the IP address here if you choose **Single** as **Source IP Type**.

Source Subnet

Type the subnet mask here if you choose **Subnet** as **Source IP Type**.

Destination IP Type

Determine the IP type as the destination.

None <input type="button" value="v"/>
None
Single
Subnet

Destination IP

Type the IP address here if you choose **Single** as **Destination IP Type**.

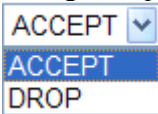
Destination Subnet	Type the subnet mask here if you choose Subnet as Destination IP Type .
Source Start Port	Type a value as the source start port. Such value will be available only TCP/UDP is selected as the protocol.
Source End Port (optional)	Type a value as the source end port. Such value will be available only TCP/UDP is selected as the protocol.
Destination Start Port	Type a value as the destination start port. Such value will be available only TCP/UDP is selected as the protocol.
Destination End Port (optional)	Type a value as the destination end port. Such value will be available only TCP/UDP is selected as the protocol.
Action	<p>Set the action that the router will perform for the packets through the protocol of IPv6.</p>  <p>Accept – If the IPv6 packets fit the condition listed in this page, the router will let it pass through. Drop - If the IPv6 packets fit the condition listed in this page, the router will block it.</p>

Example:

Refer to the following example.

- Use TSPC mode to connect to IPv6 network.
PC get ipv6 IP: 2001:5c0:1503:7400:30e4:139d:53c8:3a1e
- Connect PC to <http://www.ipv6.org/> with IPv6 IP address.
A message will appear from the web page:

Welcome to the IPv6 Information Page!
You are using IPv6 from 2001:5c0:1503:7400:30e4:139d:53c8:3a1e

- Set firewall rule to block all TCP traffic from this IP address.
- Open **IPv6 >> IPv6 Firewall Setup** and press **Add New Rule**.

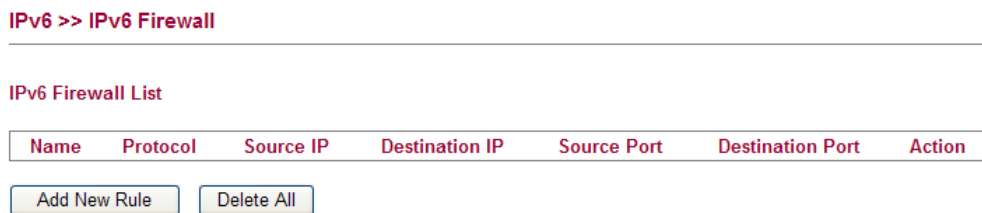

In the following dialog, please configure the page with the following values.

IPv6 >> IPv6 Firewall Setup

Add IPv6 Firewall Rule

Name	<input type="text" value="test1"/>
Protocol	TCP <input type="button" value="v"/>
Source IP Type	Single <input type="button" value="v"/>
Source IP	<input type="text" value="2001:5c0:1503:74"/>
Source Subnet	<input type="text" value=""/> / <input type="text" value="64"/>
Destination IP Type	None <input type="button" value="v"/>
Destination IP	<input type="text"/>
Destination Subnet	<input type="text"/> / <input type="text" value="64"/>
Source Start Port	<input type="text"/>
Source End Port (optional)	<input type="text"/>
Destination Start Port	<input type="text"/>
Destination End Port (optional)	<input type="text"/>
Action	Drop <input type="button" value="v"/>

5. Connect PC to <http://www.ipv6.org/> with IPv6 IP address again.
A message will appear from web page:

Welcome to the IPv6 Information Page!
You are using IPv4 from 114.37.132.219

4.10.4 IPv6 Routing

This page displays the routing table for the protocol of IPv6.

IPv6 >> IPv6 Routing Table

IPv6 Routing Table

Auto-refresh

Device	Prefix	Metric	Expires	MTU	Advms	Hoplimit
eth0	2000::/64	256	-1247sec	1500	1440	4294967295
eth1	fe80::/64	256	-1290sec	1500	1440	4294967295
br-lan	fe80::/64	256	-1289sec	1500	1440	4294967295
eth0	fe80::/64	256	-1288sec	1500	1440	4294967295
fp	fe80::/64	256	-1269sec	1500	1440	4294967295

Device	Display the interface name (eth0, eth1, fp, etc..)that used to transfer packets with addresses matching the prefix.
Prefix	The IPv6 address prefix.
Metric	Display the distance to the target (usually counted in hops). It is not used by recent kernels, but may be needed by routing daemons.
Expires	Display the lifetime of the route.
MTU	Display the largest size (in bytes) of a packet.

Advms	Display the largest size (in bytes) of an unfragmented piece of a routing advertisement.
Hoplimit	Display the number of network segments on which the packet is allowed to travel before discarded.
Auto-refresh	Check this box to enable an automatic refresh of the page at regular intervals.

4.10.5 IPv6 Neighbour

IPv6 uses neighbor discovery protocol to find out neighbors on the same link.

[IPv6 >> IPv6 Neighbour](#)

IPv6 ARP Table

Auto-refresh

Device	IP Address	Mac Address	State
--------	------------	-------------	-------

Device	The interface name of the link where the neighbor is on.
IP Address	The IPv6 address of the neighbor.
MAC Address	The link-layer address of the neighbor.
State	Possible states include: incomplete - address resolution is in progress. reachable - neighbor is reachable. stale – neighbor(s) may be unreachable but not verified until a packet is sent). delay - neighbor may be unreachable and a packet was sent. probe - neighbor may be unreachable and probes are sent to verify the reachability.
Auto-refresh	Check this box to enable an automatic refresh of the page at regular intervals.

4.10.6 IPv6 TSPC Status

IPv6 TSPC status web page could help you to diagnose the connection status of TSPC. TSPC log contains some debug information from program.

If TSPC has not configured properly, the router will display the following page when the user tries to connect through TSPC connection.

IPv6 >> IPv6 TSPC Status

The screenshot shows the IPv6 TSPC Status page with the 'Status' tab selected. The 'Connection Status' section displays 'Tunnel Status : Disconnected', which is highlighted with a red box. Below this, the 'Activity' section shows 'Sent' as 0 and 'Received' as 0.

When TSPC configuration has been done, the router will start to connect. The connecting page will be shown as below:

The screenshot shows the IPv6 TSPC Status page with the 'Status' tab selected. The 'Connection Status' section displays 'Tunnel Status : Connecting', which is highlighted with a red box. Below this, the 'Activity' section shows 'Sent' and 'Received' both as 0.

When the router detects all the information, the screen will be shown as follows. One set of **TSPC prefix** and **prefix length** will be obtained after the connection between TSPC and Tunnel broker built.

The screenshot shows the IPv6 TSPC Status page with the 'Status' tab selected. The 'Connection Status' section displays 'Tunnel Status : Connected'. The 'Tunnel Information' section is expanded, showing details such as Tunnel Interface (eth0), Tunnel Mode (IPv6-in-IPv4 (Native)), Local Endpoint Addresses (59.115.228.178 and 2001:05c0:1400:000b:0000:0000:0000:2b05), Remote Endpoint Addresses (81.171.72.11 and 2001:05c0:1400:000b:0000:0000:0000:2b04), Tspc Prefix (2001:05c0:1503:7400), Tspc Prefixlen (58), and Tunnel Broker (broker.freenet6.net). The 'Tspc Prefix' and 'Tspc Prefixlen' fields are highlighted with a red box. The 'Activity' section shows 'Sent' as 662571 and 'Received' as 1472469.

Connection Status

It will bring out different pages to represent IPv6 disconnection, connecting and connected.

Tunnel Information

Display interface name (used to send TSPC prefix), tunnel mode, local endpoint addresses, remote endpoint address, TSPC Prfix, TSPC Prefixlen (prefix length), tunnel broker and so on.

Tunnel Status

Disconnected - The remote client doesn't connect to the tunnel server.
Connecting - The remote client is connecting to the tunnel server.
Connected – The remote client has been connected to the tunnel server.

Activity

Sent - sent to the tunnel (RX bytes).
Received - received from the tunnel (RX bytes).

When the router connects to the tunnel broker, the router will use RADVD to transmit the prefix to the PC on LAN. Next, the PC will generate one set of IPv6 public IP (see the figure below). Users can use such IP for connecting to IPv6 network.

```
Microsoft Windows XP [版本 5.1.2600]
(C) Copyright 1985-2001 Microsoft Corp.

C:\Documents and Settings\user>ipconfig

Windows IP Configuration

Ethernet adapter 區域連線:

    Connection-specific DNS Suffix  . :
    IP Address. . . . .                : 192.168.1.100
    Subnet Mask . . . . .              : 255.255.255.0
    IP Address. . . . .                : 2001:5c0:1503:7400:d9c1:a2e3:4c52:1458
    IP Address. . . . .                : 2001:5c0:1503:7400:21b:fcff:feda:70f6
    IP Address. . . . .                : fe80::21b:fcff:feda:70f6%9
    Default Gateway . . . . .         : 192.168.1.1
                                       fe80::250:7fff:fe38:6135%9
```

When your PC obtains the IPv6 address, please connect to <http://www.ipv6.org>. If your PC access Internet via IPv6 connection, your IPv6 address will be shown on the web page immediately. Refer to the following figure.

IPv6

Welcome to the IPv6 Information Page!

You are using IPv6 from 2001:5c0:1503:7400:adce:274a:704:f9ec

CONTENTS

- How To
- FAQ
- IPv6 enabled applications
- IPv6 accessible servers
- IPv6 specifications
- Implementations
- Mailing List
- Other Site

4.11 User

4.11.1 User Configuration

This page allows you to set user's setting that allowed to use PPTP, FTP, IPSEC/L2TP connection.

Users

Username	Full Name	Allow Disk Sharing	Allow IPSEC/L2TP	Allow PPTP	Allow FTP
draytek	draytek	✓	✓	✓	✓

Add a New User

Adding a New User

Click **Add a New User** to open the following page.

User Configuration

Add User

User Settings	
Username	<input type="text" value="carrie"/>
Full Name	<input type="text" value="carrie ni"/>
Password	<input type="password" value="••••••"/>
Confirm Password	<input type="password" value="••••••"/>
Allow Disk Sharing	<input checked="" type="checkbox"/>
Allow IPSEC/L2TP	<input checked="" type="checkbox"/>
Allow PPTP	<input checked="" type="checkbox"/>
Allow FTP	<input checked="" type="checkbox"/>

OK

Cancel

Username	Type a name for this user.
Full Name	Type full name for this user.
Password	Type the password for this user.
Confirm Password	Type the password again for confirmation.
Allow Disk Sharing	Check this box to have the remote user share the disk information.
Allow IPSEC/L2TP	Check this box to let the remote user connecting to this device through IPSEC/L2TP.
Allow PPTP	Check this box to let the remote user connecting to this device through PPTP.
Allow FTP	Check this box to let the remote user connecting to FTP server via this router.
Delete User	Remove settings on current page and delete the user. This button is not available for new configuration by pressing Add a New User .

When you finish the settings, simply click **OK** to save the configuration. The new user will be created and displayed on the page.

Users

Users

Username	Full Name	Allow Disk Sharing	Allow IPSEC/L2TP	Allow PPTP	Allow FTP
carrie	carrie ni	✓	✓	✓	✓

Add a New User

Editing/Deleting User Settings

To edit a user, click the name link under Username to open the following page. Modify the settings except Username and then click **OK** to save and exit it. If you want to remove such user settings, simply click **Delete User**.

User Configuration

Edit User

User Settings	
Username	<input type="text" value="carrie"/>
Full Name	<input type="text" value="carrie ni"/>
Password	<input type="password" value="••••"/>
Confirm Password	<input type="password" value="••••"/>
Allow Disk Sharing	<input type="checkbox"/>
Allow IPSEC/L2TP	<input type="checkbox"/>
Allow PPTP	<input type="checkbox"/>
Allow FTP	<input type="checkbox"/>

OK Cancel Delete User

4.12 System Maintenance

For the system setup, there are several items that you have to know the way of configuration: Status, User Password, Configuration Backup, Syslog/Mail Alert, Time and Date, Management, Reboot System, and Firmware Upgrade.

Below shows the menu items for System Maintenance.

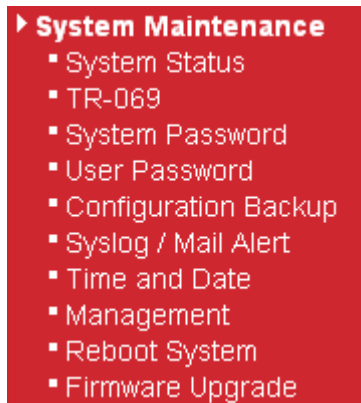

4.12.1 System Status

The **System Status** provides basic network settings of Vigor router. It includes LAN and WAN interface information. Also, you could get the current running firmware version or firmware related information from this presentation.

Model Name	Display the model name of the router.
Firmware Version	Display the firmware version of the router.
Build Date/Time	Display the date and time of the current firmware build.
System Date	Display current time and date for the system server.
System Uptime	Display the connection time for the system server.
System-----	

CPU Usage	Display the percentage of the CPU usage of your system.
Memory Usage	Display the size of the memory usage and the percentage.
<i>LAN-----</i>	
MAC Address	Display the MAC address of the LAN Interface.
IP Address	Display the IP address of the LAN interface.
IP Mask	Display the subnet mask address of the LAN interface.
IPv6 Address (Global)	Display the global IPv6 address of the LAN interface.
IPv6 Address (Link)	Display the link local IPv6 address of the LAN interface.
DHCP Server	Display if the DHCP server is active or not.
<i>WAN-----</i>	
Connection Mode	Display current connection type used.
Link Status	Display the connection status.
MAC Address	Display the MAC address of the WAN Interface.
IP Address	Display the IP address of the WAN interface.
IP Mask	Display the subnet mask address of the WAN interface.
IPv6 Address (Link)	Display the IPv6 address of the WAN interface.
Default Gateway	Display the gateway address of the WAN interface.
Primary DNS	Display the specified primary DNS setting.
Secondary DNS	Display the specified secondary DNS setting.
<i>Wireless LAN-----</i>	
MAC Address	Display the MAC address of the wireless LAN.
Device Type	Display the device type used for wireless LAN.
SSID	Display the SSID of the router.
Channel	Display the channel that wireless LAN used.
Manufacturer	Display the manufacturer of the disk.
Model	Display the model of the disk.
Size	Display the storage size of the USB diskette.
Status	Display current status of the USB diskette.

4.12.2 TR-069

Vigor router with TR-069 is available for matching with VigorACS server. Such page provides VigorACS and CPE settings under TR-069 protocol. All the settings configured here is for CPE to be controlled and managed with VigorACS server. Users need to type URL, username and password for the VigorACS server that such device will be connected. However URL, username and password under CPE client are fixed that users cannot change it. The default CPE username and password are "vigor" and "password". You will need it when you configure VigorACS server.

System Maintenance >> TR-069 Setting

ACS Settings

URL	<input type="text"/>
Username	<input type="text"/>
Password	<input type="password"/>

CPE Settings

Enable	<input type="checkbox"/>
URL	<input type="text" value="http://172.16.3.102:8069/cwm/CRN.html"/>
Port	<input type="text" value="8069"/>
Username	<input type="text" value="vigor"/>
Password	<input type="password"/>

Periodic Inform Settings

Enable	<input checked="" type="checkbox"/>
Interval Time	<input type="text" value="300"/> second(s)

OK

ACS Settings

Such data must be typed according to the ACS (Auto Configuration Server) you want to link. Please refer to VigorACS user's manual for detailed information.

URL - Type the URL for VigorACS server.

If the connected CPE needs to be authenticated, please set URL as the following and type username and password for VigorACS server:

http://{IP address of VigorACS}:8080/ACSServer/services/ACSServlet

If the connected CPE does not need to be authenticated please set URL as the following:

http://{IP address of VigorACS}:8080/ACSServer/services/UnAuthACSServlet

Username/Password - Type username and password for ACS Server for authentication. For example, if you want to use such CPE with VigorACS, you can type as the following:

Username: *acs*

Password: *password*

CPE Settings

Such information is useful for Auto Configuration Server.

Enable/Disable – Allow/Deny the CPE Client to connect with Auto Configuration Server.

Port – Sometimes, port conflict might be occurred. To solve such problem, you might change port number for CPE.

Periodic Inform Settings

Disable – The system will not send inform message to

ACS server.

Enable – The system will send inform message to ACS server periodically (with the time set in the box of interval time).

The default setting is **Enable**. Please set interval time or schedule time for the router to send notification to CPE. Or click **Disable** to close the mechanism of notification.

4.12.3 System Password

This page allows you to set new password for admin operation.

[System Maintenance >> System Password](#)

System Password

Old Password	<input type="text"/>
New Password	<input type="text"/>
Confirm New Password	<input type="text"/>

Old Password

Type in the old password. The factory default setting for password is blank.

New Password

Type in new password in this filed.

Confirm Password

Type in the new password again.

When you click OK, the login window will appear. Please use the new password to access into the web configurator again.

4.12.4 User Password

This page allows you to set new password for user operation.

[System Maintenance >> User Password](#)

User Password

Old Password	<input type="text"/>
New Password	<input type="text"/>
Confirm New Password	<input type="text"/>

Old Password

Type in the old password. The factory default setting for password is blank.

New Password

Type in new password in this filed.

Confirm Password

Type in the new password again.

When you click **OK**, the login window will appear. Please use the new password to access into the web configurator again.

4.12.5 Configuration Backup

Backup the Configuration

Follow the steps below to backup your configuration.

1. Go to **System Maintenance >> Configuration Backup**. The following windows will be popped-up, as shown below.

System Maintenance >> Configuration Backup

Configuration Backup / Restoration

Backup

Please specify a key and click Backup to download current running configurations as a encrypted file.

Key (optional):

Note: You will need the same key to do configuration restoration.

Restoration

Select a configuration file.

Please enter the key and click Restore to upload the configuration file.

key (optional):

2. Type a key arbitrarily for encrypting the file. Keep the key in mind. You will need it whenever you want to restore such file. Click **Backup** button to get into the following dialog. Click **Save** button to open another dialog for saving configuration as a file.

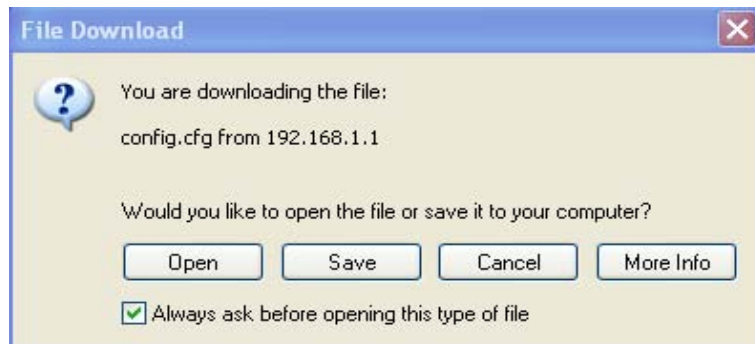

3. In **Save As** dialog, the default filename is **config.cfg**. You could give it another name by yourself.

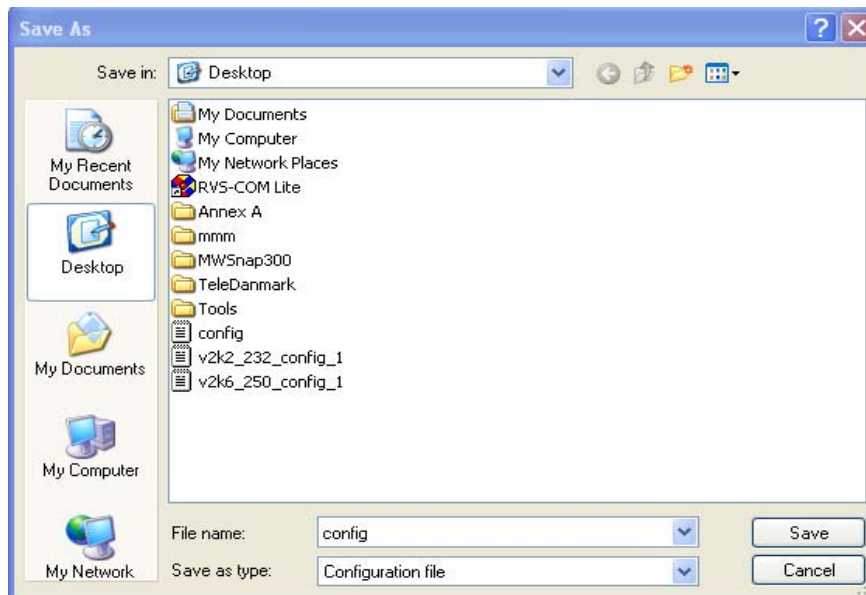

4. Click **Save** button, the configuration will download automatically to your computer as a file named **config.cfg**.

The above example is using **Windows** platform for demonstrating examples. The **Mac** or **Linux** platform will appear different windows, but the backup function is still available.

Note: Backup for Certification must be done independently. The Configuration Backup does not include information of Certificate.

Restore Configuration

1. Go to **System Maintenance >> Configuration Backup**. The following windows will be popped-up, as shown below.

System Maintenance >> Configuration Backup

Configuration Backup / Restoration

Backup

Please specify a key and click Backup to download current running configurations as a encrypted file.

Key (optional):

Note: You will need the same key to do configuration restoration.

Restoration

Select a configuration file.

Please enter the key and click Restore to upload the configuration file.

key (optional):

2. Click **Browse** button to choose the correct configuration file for uploading to the router.
3. Click **Restore** button and wait for few seconds, the following picture will tell you that the restoration procedure is successful.

Note: If the file you want to restore has been encrypted, you will be asked to type the encrypted key before clicking **Restore**.

4.12.6 Syslog/Mail Alert

SysLog function is provided for users to monitor router. There is no bother to directly get into the Web Configurator of the router or borrow debug equipments.

Maintenance >> Syslog / Mail Alert Setup

Syslog Access Setup

Enable	<input type="checkbox"/>
Router Name	<input type="text" value="Vigor2130"/>
Server IP Address	<input type="text"/>
Destination Port	<input type="text" value="514"/>
Log Level	<input type="text" value="All"/>

Mail Alert Setup

Enable	<input type="checkbox"/>
SMTP Server	<input type="text"/>
Mail To	<input type="text"/>
Mail From	<input type="text"/>
User Name	<input type="text"/>
Password	<input type="text"/>
Enable E-Mail Alert:	<input checked="" type="checkbox"/> User Login

Enable (Syslog Access...)

Check “**Enable**” to activate function of syslog.

Router Name

Assign a name of this device.

Server IP Address

The IP address of the Syslog server.

Destination Port

Assign a port for the Syslog protocol.

Log Level

Choose the severity level for the system log entry.

All	▼
All	
Info	
Warning	
Error	

Enable (Mail Alert...)

Check “**Enable**” to activate function of mail alert.

SMTP Server

The IP address of the SMTP server.

Mail To

Assign a mail address for sending mails out.

Mail From

Assign a path for receiving the mail from outside.

User Name

Type the user name for authentication.

Password

Type the password for authentication.

Enable E-mail Alert

Check the box of User Login to send alert message to the e-mail box while the router detecting the item(s) you specify here.

Click **OK** to save these settings.

For viewing the Syslog, please do the following:

1. Just set your monitor PC's IP address in the field of Server IP Address

2. Install the Router Tools in the **Utility** within provided CD. After installation, click on the **Router Tools>>Syslog** from program menu.

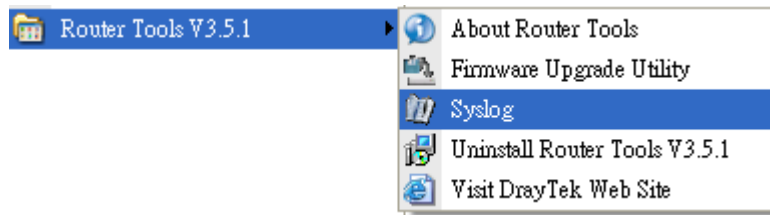

3. From the Syslog screen, select the router you want to monitor. Be reminded that in **Network Information**, select the network adapter used to connect to the router. Otherwise, you won't succeed in retrieving information from the router.

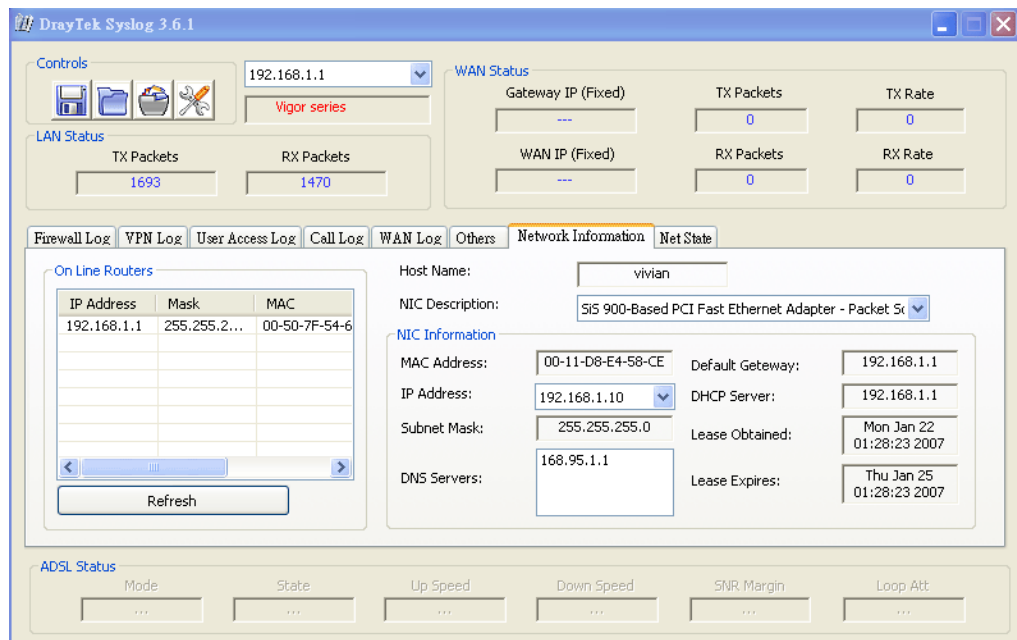

4.12.7 Time and Date

It allows you to specify where the time of the router should be inquired from.

System Maintenance >> Time and Date

Time Information

Current System Time	Tue Oct 27 03:41:37 UTC 2009	Inquire Time
---------------------	------------------------------	--------------

Time Configuration

Time Zone	
Unknown ▼	
NTP Servers	
Delete	pool.ntp.org
Delete	time.windows.com
Delete	time.nist.gov
Delete	time.stdtime.gov.tw
Add NTP server	

OK	Cancel
----	--------

Current System Time

Click **Inquire Time** to get the current time.

Time Zone

Select the time zone where the router is located.

Add NTP server

Click the button to add a new NTP server.

Delete

Click this button to remove an NTP server.

Click **OK** to save these settings.

4.12.8 Management

This page allows you to manage the settings for access control, access list, port setup, and SMP setup. For example, as to management access control, the port number is used to send/receive SIP message for building a session. The default value is 5060 and this must match with the peer Registrar when making VoIP calls.

System Maintenance >> Remote Management

Management Access Control

<p>Allow management from the Internet</p> <p>Enable HTTP <input type="checkbox"/> 80</p> <p>Enable HTTPS <input type="checkbox"/> 443</p> <p>Enable SSH <input type="checkbox"/> 22</p> <p>Enable ICMP Ping <input type="checkbox"/></p> <p>Enable FTP <input type="checkbox"/> 21</p> <p>Enable TELNET <input type="checkbox"/> 23</p>		<p>SNMP Setup</p> <p>Enable SNMP <input type="checkbox"/> 161</p> <p>Manager Host IP <input type="text"/></p>												
<p>Access List</p> <table border="1"> <thead> <tr> <th>List</th> <th>IP</th> <th>Subnet Mask</th> </tr> </thead> <tbody> <tr> <td>1</td> <td><input type="text"/></td> <td>255.255.255.255 / 32 ▼</td> </tr> <tr> <td>2</td> <td><input type="text"/></td> <td>255.255.255.255 / 32 ▼</td> </tr> <tr> <td>3</td> <td><input type="text"/></td> <td>255.255.255.255 / 32 ▼</td> </tr> </tbody> </table>			List	IP	Subnet Mask	1	<input type="text"/>	255.255.255.255 / 32 ▼	2	<input type="text"/>	255.255.255.255 / 32 ▼	3	<input type="text"/>	255.255.255.255 / 32 ▼
List	IP	Subnet Mask												
1	<input type="text"/>	255.255.255.255 / 32 ▼												
2	<input type="text"/>	255.255.255.255 / 32 ▼												
3	<input type="text"/>	255.255.255.255 / 32 ▼												

OK

Enable HTTP/HTTPS/SSH/ICMP Ping/FTP/TELNET

Enable the checkbox to allow system administrators to login from the Internet. There are several servers provided by the system to allow you managing the router from Internet. Check the box(es) to specify.

Enable SNMP

Check it to enable such service.

Manager Host IP – Set one host as the manager to execute SNMP function. Type the IP address to specify the certain host.

Access List

You could specify that the system administrator can only login from a specific host or network defined in the list. A maximum of three IPs/subnet masks is allowed.

List IP - Indicate an IP address allowed to login to the router.

Subnet Mask - Represent a subnet mask allowed to login to the router.

4.12.9 Reboot System

The Web Configurator may be used to restart your router for using current configuration. Click **Reboot System** from **System Maintenance** to open the following page.

System Maintenance >> Reboot System

Reboot System

Do You want to reboot your router ?

Using current configuration
 Using factory default configuration

Click **OK**. The router will take 5 seconds to reboot the system.

Note: When the system pops up Reboot System web page after you configure web settings, please click **OK** to reboot your router for ensuring normal operation and preventing unexpected errors of the router in the future.

4.12.10 Firmware Upgrade

Before upgrading your router firmware, you need to install the Router Tools. The **Firmware Upgrade Utility** is included in the tools. The following web page will guide you to upgrade firmware by using an example. Note that this example is running over Windows OS (Operating System).

Download the newest firmware from DrayTek's web site or FTP site. The DrayTek web site is www.draytek.com (or local DrayTek's web site) and FTP site is [ftp.draytek.com](ftp://draytek.com).

Click **Maintenance>> Firmware Upgrade** to launch the Firmware Upgrade Utility.

System Maintenance >> Firmware Upgrade

Firmware Upgrade

Current Firmware Version: v1.3.0

Select a firmware file.

Click Upgrade to upload the file.

Note: It is strongly recommended that you do a configuration backup before upgrading.

Click **Browse..** to locate the newest firmware and click **Upgrade**. During the process of upgrade, do not turn off your router.

4.13 Diagnostics

Diagnostic Tools provide a useful way to **view** or **diagnose** the status of your Vigor router.

Below shows the menu items for Diagnostics.

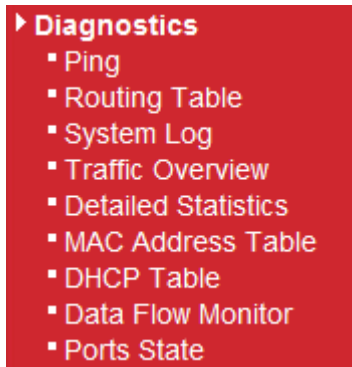

4.13.1 Ping

Click **Diagnostics** and click **Ping** to open the web page. It is used to troubleshoot IP connection for your router.

Diagnostics >> Ping

ICMP Ping

IP Address	<input type="text" value="0.0.0.0"/>
Ping Size	<input type="text" value="64"/>

IP Address

Type in the IP address of the Host/IP that you want to ping.

Ping Size

Type in the payload size of the ICMP packet. Values range from 8 bytes to 1400 bytes.

Start

Click this button to start the ping work. The result will be displayed on the screen.

4.13.2 Routing Table

Click **Diagnostics** and click **Routing Table** to open the web page.

[Diagnostics >> Routing Table](#)

Routing Table

Auto-refresh

Destination	Gateway	Genmask	Flags	Metric	Ref	Use	Iface
192.168.5.0	0.0.0.0	255.255.255.0	U	0	0	0	eth1
192.168.1.0	0.0.0.0	255.255.255.0	U	0	0	0	br-lan
211.100.88.0	192.168.1.3	255.255.255.0	UG	0	0	0	br-lan
192.168.10.0	192.168.1.2	255.255.255.0	UG	0	0	0	br-lan
0.0.0.0	192.168.5.1	0.0.0.0	UG	0	0	0	eth1

Destination	Display the IP address for destination network or destination host.
Gateway	Display the gateway address or “*” if none set.
Genmask	Display the netmask for the destination net; '255.255.255.255' is for a host destination and '0.0.0.0' is for the default route.
Flags	Different codes represent different routing status. U - route is up. H - target is a host G - use gateway R - reinstate route for dynamic routing D - dynamically installed by daemon or redirect M - modified from routing daemon or redirect A - installed by addrconf C - cache entry ! - reject route
Metric	Display the distance to the target (usually counted in hops).
Ref	Display number of references to this route. (Not used in the Linux kernel.)
Use	Display count of lookups for the route. Depending on the use of -F and -C, this will be either route cache misses (-F) or hits (-C).
Iface	Display interface to which packets for this route will be sent.
Refresh	Click it to reload the page.

4.13.3 System Log

Click **Diagnostics** and click **System Log** to open the web page.

[Diagnostics >> System Log](#)

System Log Information

Auto-refresh Reverse

Time	Level	Type	Message
Apr 20 02:00:03	info	daemon	dnsmasq[3292]: DHCPACK(br-lan) 192.168.1.10 e0:cb:4e:da:48:79 carrie-0c7cb251
Apr 20 02:00:03	info	daemon	dnsmasq[3292]: DHCPINFORM(br-lan) 192.168.1.10 e0:cb:4e:da:48:79
Apr 20 02:00:00	info	daemon	dnsmasq[3292]: DHCPACK(br-lan) 192.168.1.10 e0:cb:4e:da:48:79 carrie-0c7cb251
Apr 20 02:00:00	info	daemon	dnsmasq[3292]: DHCPINFORM(br-lan) 192.168.1.10 e0:cb:4e:da:48:79
Apr 19 23:39:26	info	daemon	dnsmasq[3292]: DHCPACK(br-lan) 192.168.1.10 e0:cb:4e:da:48:79 carrie-0c7cb251
Apr 19 23:39:26	info	daemon	dnsmasq[3292]: DHCPREQUEST(br-lan) 192.168.1.10 e0:cb:4e:da:48:79
Apr 19 21:08:56	info	user	: Enable SHNAT
Apr 19 21:08:55	warn	user	kernel: gvid = 2 (gvid&0xFF) << 16= 20000
Apr 19 21:08:55	warn	user	kernel: gvid = 2 0x1 <<gvid <<16= 40000
Apr 19 21:08:55	info	user	: Disable SHNAT
Apr 19 21:08:55	notice	user	root: starting ntpclient
Apr 19 21:08:51	info	user	: killall: igmpproxy: no process killed
Apr 19 21:08:50	notice	user	root: stopping ntpclient

- Time** Display the time of the system log entry.
- Level** Display the severity level of the system log entry.
- Type** Display the type or subsystem of the system log entry.
- Message** Display a short description of the system log entry.
- Auto-refresh** Check it to enable auto-refresh function.
- Reverse** Check it to have newest log entries presented first.
- Refresh** Click it to reload the page.
- Export** Click it to export the log as a text file.

4.13.4 Traffic Overview

This page offers an overview of general traffic statistics for all connecting ports.

[Diagnostics >> Traffic Overview](#)

Port Statistics Overview

Auto-refresh

Port	Packets		Bytes		Errors		Drops		Filtered
	Receive	Transmit	Receive	Transmit	Receive	Transmit	Receive	Transmit	Receive
WAN	38471	16525	15432151	3128250	0	0	0	0	0
LAN1	0	0	0	0	0	0	0	0	0
LAN2	18630	16062	3349573	13192564	0	0	0	0	0
LAN3	0	0	0	0	0	0	0	0	0
LAN4	0	0	0	0	0	0	0	0	0

- Port** Display the interface that data transmission passing through.

Packets	Display the packet sizes for data transmission in receiving and sending.
Bytes	Display the number of received and transmitted bytes per port.
Errors	Display the number of the error occurred in data receiving and data sending.
Drops	Display the number of the data lost in receiving and sending.
Filtered	Display the number of received frames filtered by the forwarding process.
Auto-refresh	Check it to enable auto-refresh function.
Refresh	Click it to reload the page.
Clear	Click it to clear the counters for all ports.

4.13.5 Detailed Statistics

This page display detailed statistics for WAN/LAN interface.

[Diagnostics >> Detailed Statistics](#)

Detailed Port Statistics WAN

WAN

Receive Total		Transmit Total	
Rx Packets	38618	Tx Packets	16552
Rx Octets	15458804	Tx Octets	3133089
Rx Unicast	18389	Tx Unicast	16549
Rx Multicast	5687	Tx Multicast	0
Rx Broadcast	14542	Tx Broadcast	3
Rx Pause	0	Tx Pause	0
Receive Size Counters		Transmit Size Counters	
Rx 64 Bytes	5971	Tx 64 Bytes	9935
Rx 65-127 Bytes	17150	Tx 65-127 Bytes	2395
Rx 128-255 Bytes	3806	Tx 128-255 Bytes	164
Rx 256-511 Bytes	2698	Tx 256-511 Bytes	2385
Rx 512-1023 Bytes	1463	Tx 512-1023 Bytes	1257
Rx 1024-1526 Bytes	7530	Tx 1024-1526 Bytes	416
Rx 1527- Bytes	0	Tx 1527- Bytes	0
Receive Queue Counters		Transmit Queue Counters	
Rx Low	20334	Tx Low	1722
Rx Normal	3931	Tx Normal	0
Rx Medium	14353	Tx Medium	14830
Rx High	0	Tx High	0
Receive Error Counters		Transmit Error Counters	
Rx Drops	0	Tx Drops	0
Rx CRC/Alignment	0	Tx Late/Exc. Coll.	0
Rx Undersize	0		
Rx Oversize	0		
Rx Fragments	0		
Rx Jabber	0		
Rx Filtered	0		

Rx Packets	Display the counting number of the packet received.
Rx Octets	Display the total received bytes.
Rx Unicast	Display the counting number of the received unicast packet.

Rx Broadcast	Display the counting number of the received broadcast packet.
Rx Pause	Display the counting number of the received pause packet.
RX 64 Bytes	Display the number of 64-byte frames in good and bad packets received.
RX 65-127 Bytes	Display the number of 65 ~ 127-byte frames in good and bad packets received.
RX 128-255 Bytes	Display the number of 128 ~ 255-byte frames in good and bad packets received.
RX 256-511 Bytes	Display the number of 256 ~ 511-byte frames in good and bad packets received.
RX 512-1023 Bytes	Display the number of 512 ~ 1023-byte frames in good and bad packets received.
RX 1024- 1526 Bytes	Display the number of 1024-1522-byte frames in good and bad packets received.
RX 1527 Bytes	Display the number of 1527-byte frames in good and bad packets received.
Rx Low	Display the low queue counter of the packet received.
Rx Normal	Display the normal queue counter of the packet received.
Rx Medium	Display the medium queue counter of the packet received.
Rx High	Display the high queue counter of the packet received.
Rx Drops	Display the number of frames dropped due to the lack of receiving buffer.
Rx CRC/Alignment	Display the number of Alignment errors packets received.
Rx Undersize	Display the number of short frames (<64 Bytes) with valid CRC.
Rx Oversize	Display the number of long frames (according to max_length register) with valid CRC.
Rx Fragments	Display the number of short frames (< 64 bytes) with invalid CRC.
Rx Jabber	Display the number of long frames (according to max_length register) with invalid CRC.
Rx Filtered	Display the filtered number of the packet received.
Tx Packets	Display the counting number of the packet transmitted.
Tx Octets	Display the total transmitted bytes.
Tx Unicast	Display the show the counting number of the transmitted unicast packet.
Tx Multicast	Display the show the counting number of the transmitted multicast packet.
Tx Broadcast	Display the counting number of the transmitted broadcast packet.
Tx Pause	Show the counting number of the transmitted pause packet.

Tx 64 Bytes	Display the number of 64-byte frames in good and bad packets transmitted.
Tx 65-127 Bytes	Display the number of 65 ~ 127-byte frames in good and bad packets transmitted.
Tx 128-255 Bytes	Display the number of 128 ~ 255-byte frames in good and bad packets transmitted.
Tx 256-511 Bytes	Display the number of 256 ~ 511-byte frames in good and bad packets transmitted.
Tx 512-1023 Bytes	Display the number of 512 ~ 1023-byte frames in good and bad packets transmitted.
Tx 1024- 1526 Bytes	Display the number of 1024 ~ 1522-byt frames in good and bad packets transmitted.
Tx 1527 Bytes:	Display the number of 1527-byte frames in good and bad packets transmitted.
Tx Low	Display the low queue counter of the packet transmitted.
Tx Normal	Display the normal queue counter of the packet transmitted.
Tx Medium	Display the medium queue counter of the packet received.
Tx High	Display the high queue counter of the packet received.
Tx Drops	Display the number of frames dropped due to excessive collision, late collision, or frame aging.
Tx lat/Exc.Coll.	Display the number of Frames late collision or excessive collision Error, which switch transmitted
Auto-refresh	Check it to enable auto-refresh function.
Refresh	Click it to reload the page.
Clear	Click it to clear the counters for all ports.

4.13.6 MAC Address Table

The MAC Address Table contains up to 8192 entries, and is sorted first by VLAN ID, then by MAC address.

Each page shows up to 999 entries from the MAC table, default being 20, selected through the "entries per page" input field. When first visited, the web page will show the first 20 entries from the beginning of the MAC Table. The first displayed will be the one with the lowest VLAN ID and the lowest MAC address found in the MAC Table.

The **Start from MAC address** and **VLAN** input fields allow the user to select the starting point in the MAC Table. Clicking the **Refresh** button will update the displayed table starting from that or the closest next MAC Table match. In addition, the two input fields will assume the value of the first displayed entry, allowing for continuous refresh with the same start address.

The button >> will use the last entry of the currently displayed VLAN/MAC address pairs as a basis for the next lookup. When the end is reached the text "no more entries" is shown in the displayed table, use the << button to start over.

Diagnostics >> MAC Address Table

MAC Address Table

Auto-refresh Refresh Clear |<< >>

Start from VLAN and MAC address with entries per page.

Type	VLAN	MAC Address	CPU	WAN	Port Members			
					LAN1	LAN2	LAN3	LAN4
Dynamic	1	00-0E-A6-2A-D5-A1				✓		
Dynamic	1	00-50-7F-38-60-C5						
Dynamic	2	00-06-1B-D0-DF-A1		✓				
Dynamic	2	00-0C-6E-E7-79-99		✓				
Dynamic	2	00-0E-A6-16-0A-24		✓				
Dynamic	2	00-1B-FC-F8-11-40		✓				
Dynamic	2	00-50-7F-1A-56-71		✓				
Dynamic	2	00-50-7F-38-60-C6						

- Type** Indicate whether the entry is a static or dynamic entry.
- VLAN** Display the VLAN ID of that entry.
- MAC Address** Display the MAC address of that entry.
- Port Members** Display the port of that entry.
- Auto-refresh** Check it to enable auto-refresh function.
- Refresh** Click it to reload the page.
- Clear** Click it to clear the whole table.

4.13.7 DHCP Table

The facility provides information on IP address assignments. This information is helpful in diagnosing network problems, such as IP address conflicts, etc.

Click **Diagnostics** and click **DHCP Table** to open the web page.

[Diagnostics >> DHCP Table](#)

DHCP Server Status

Auto-refresh

Computer Name	IP Address	MAC Address	Expire Time
WM_Administrat3	192.168.1.127	00:18:41:e0:f9:e3	7 Hours 9 Minutes
user-6a0e182ce8	192.168.1.178	00:0e:a6:2a:d5:a1	8 Hours 51 Minutes

- Computer Name** It displays the name of the computer accepted the assigned IP address by this router.
- IP Address** It displays the IP address assigned by this router for specified PC.
- MAC Address** It displays the MAC address for the specified PC that DHCP assigned IP address for it.
- Expire Time** It displays the leased time of the specified PC.
- Auto-refresh** Check it to enable auto-refresh function.
- Refresh** Click it to reload the page.

4.13.8 Data Flow Monitor

This page displays the running procedure for the IP address monitored and refreshes the data in an interval of several seconds. The IP address listed here is configured in Bandwidth Management. You have to enable IP bandwidth limit and IP session limit before invoke Data Flow Monitor. If not, a notification dialog box will appear to remind you enabling it.

Click **Diagnostics** and click **Data Flow Monitor** to open the web page. You can click **IP Address**, **TX rate**, **RX rate** or **Session** link for arranging the data display.

[Diagnostics >> Data Flow Monitor](#)

Page: 1

Index	IP Address	TX rate(Kbps)	RX rate(Kbps)	Hardware NAT rate(Kbps)	Session	Action
1	192.168.1.10	0	0	0	2	Block
2						
3						
4						
5						
6						
7						
8						
9						
10						
11						
12						
13						
14						
15						
Total					2	

- Note:**
1. Click "Block" to prevent specified PC from surfing Internet for 5 minutes.
 2. The IP blocked by the router will be shown in red.
 3. If Hardware NAT is enabled, 'Hardware NAT rate' shows TX + RX bandwidth which goes through Hardware NAT.

- Auto-refresh** Check it to enable auto-refresh function.
- Refresh** Click this link to refresh this page manually.
- Index** Display the number of the data flow.
- IP Address** Display the IP address of the monitored device.
- TX rate (kbps)** Display the transmission speed of the monitored device.
- RX rate (kbps)** Display the receiving speed of the monitored device.
- Hardware NAT rate** Display the data processing rate of the monitored device if hardware NAT is enabled.
- Sessions** Display the session number that you specified in Limit Session web page.
- Action** **Block** - can prevent specified PC accessing into Internet within 5 minutes.

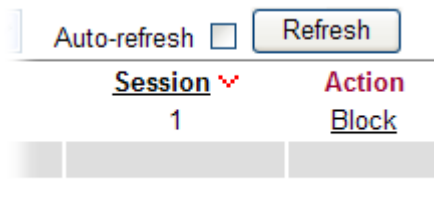

Unblock – the device with the IP address will be blocked

in five minutes. The remaining time will be shown on the session column.

Auto-refresh

Session	Action
5	Unblock

4.13.9 Ports State

Click **Diagnostics** and click **Ports State** to open the list page. There are for LAN ports and one WAN port in your router. Through this page, you can know which port is using and you can get the detailed statistics for each port by moving and clicking the mouse on the connected one.

Port State Overview

Auto-refresh

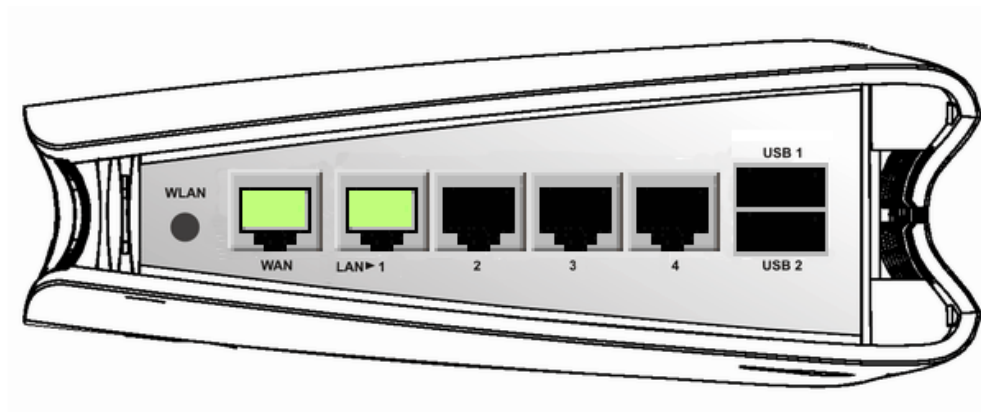

Auto-refresh

Check it to enable auto-refresh function.

Refresh

Click it to reload the page if you change the LAN port connection. Or you can check Auto-refresh to reload the page by the system automatically.

This page is left blank.

5

Trouble Shooting

This section will guide you to solve abnormal situations if you cannot access into the Internet after installing the router and finishing the web configuration. Please follow sections below to check your basic installation status stage by stage.

- Checking if the hardware status is OK or not.
- Checking if the network connection settings on your computer are OK or not.
- Pinging the router from your computer.
- Checking if the ISP settings are OK or not.
- Backing to factory default setting if necessary.

If all above stages are done and the router still cannot run normally, it is the time for you to contact your dealer for advanced help.

5.1 Checking If the Hardware Status Is OK or Not

Follow the steps below to verify the hardware status.

1. Check the power line and WLAN/LAN cable connections. Refer to “**1.3 Hardware Installation**” for details.
2. Turn on the router. Make sure the **ACT LED** blink once per second and the correspondent **LAN LED** is bright.

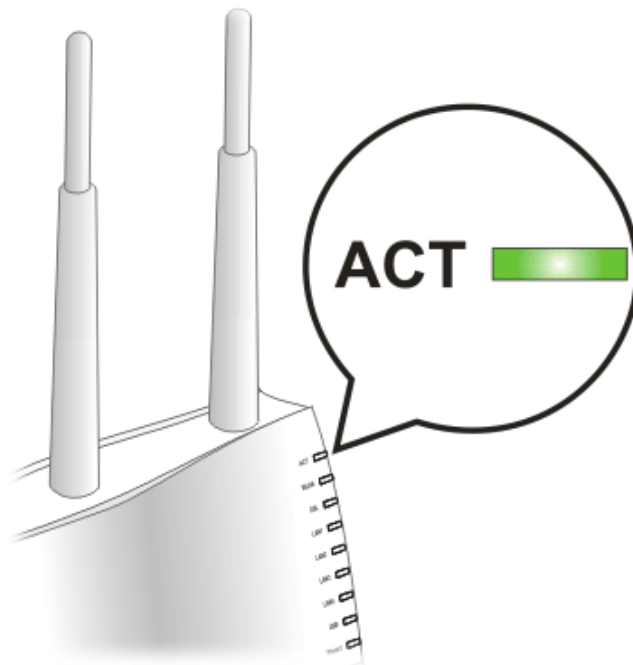

3. If not, it means that there is something wrong with the hardware status. Simply back to “**1.3 Hardware Installation**” to execute the hardware installation again. And then, try again.

5.2 Checking If the Network Connection Settings on Your Computer Is OK or Not

Sometimes the link failure occurs due to the wrong network connection settings. After trying the above section, if the link is still failed, please do the steps listed below to make sure the network connection settings is OK.

For Windows



The example is based on Windows XP. As to the examples for other operation systems, please refer to the similar steps or find support notes in www.draytek.com.

1. Go to **Control Panel** and then double-click on **Network Connections**.



2. Right-click on **Local Area Connection** and click on **Properties**.

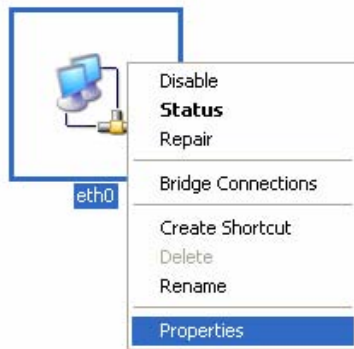

3. Select **Internet Protocol (TCP/IP)** and then click **Properties**.

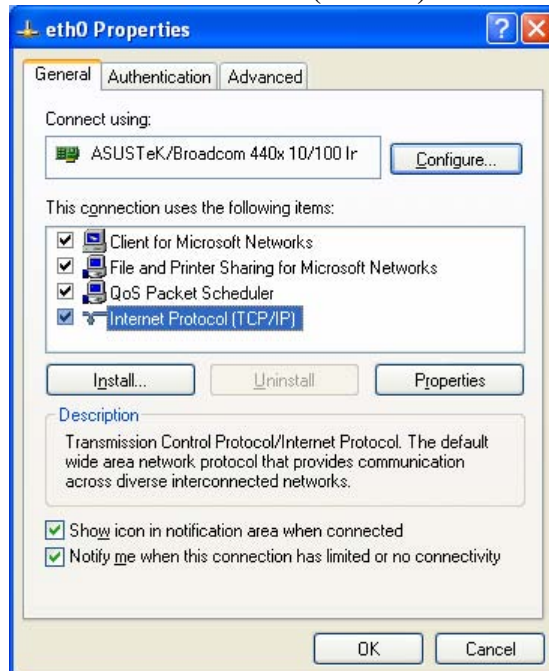

4. Select **Obtain an IP address automatically** and **Obtain DNS server address automatically**.

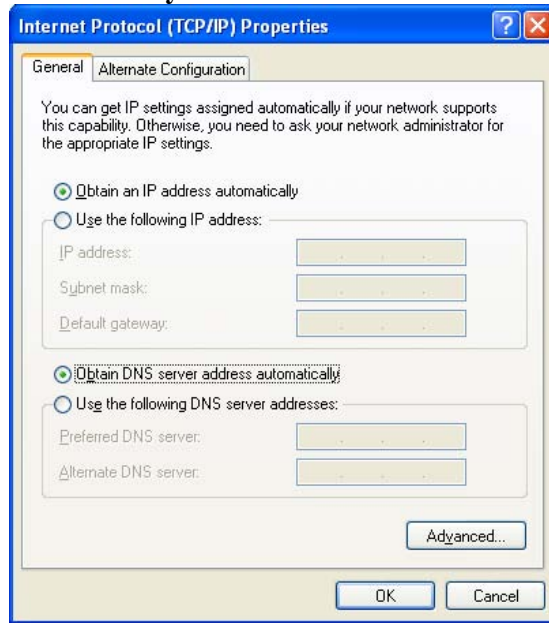

For MacOs

1. Double click on the current used MacOs on the desktop.
2. Open the **Application** folder and get into **Network**.
3. On the **Network** screen, select **Using DHCP** from the drop down list of Configure IPv4.

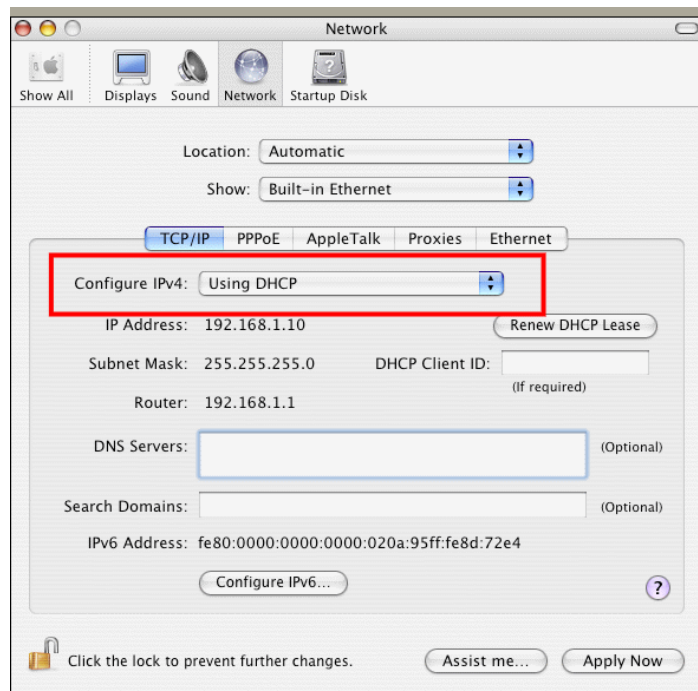

5.3 Pinging the Router from Your Computer

The default gateway IP address of the router is 192.168.1.1. For some reason, you might need to use “ping” command to check the link status of the router. **The most important thing is that the computer will receive a reply from 192.168.1.1.** If not, please check the IP address of your computer. We suggest you setting the network connection as **get IP automatically**. (Please refer to the section 5.2)

Please follow the steps below to ping the router correctly.

For Windows

1. Open the **Command Prompt** window (from **Start menu**> **Run**).
2. Type **command** (for Windows 95/98/ME) or **cmd** (for Windows NT/ 2000/XP/Vista). The DOS command dialog will appear.

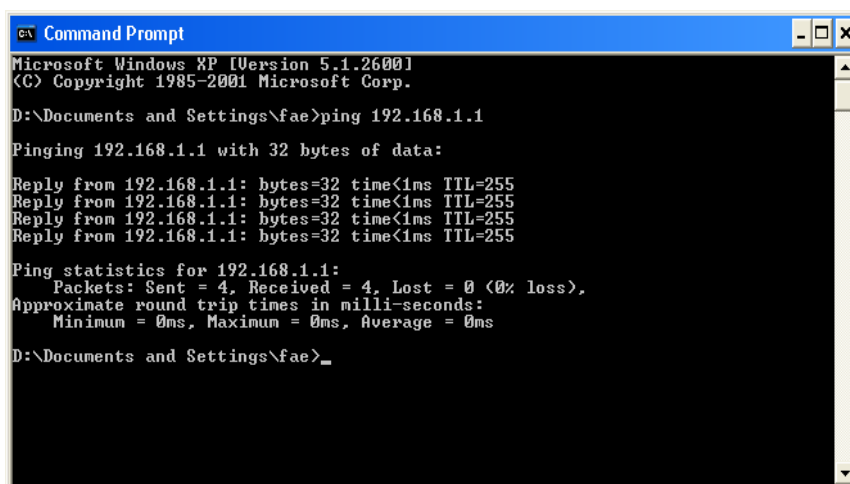

```
Microsoft Windows XP [Version 5.1.2600]
(C) Copyright 1985-2001 Microsoft Corp.

D:\Documents and Settings\fae>ping 192.168.1.1

Pinging 192.168.1.1 with 32 bytes of data:

Reply from 192.168.1.1: bytes=32 time<1ms TTL=255
Reply from 192.168.1.1: bytes=32 time<1ms TTL=255
Reply from 192.168.1.1: bytes=32 time<1ms TTL=255
Reply from 192.168.1.1: bytes=32 time<1ms TTL=255

Ping statistics for 192.168.1.1:
    Packets: Sent = 4, Received = 4, Lost = 0 (0% loss),
    Approximate round trip times in milli-seconds:
        Minimum = 0ms, Maximum = 0ms, Average = 0ms

D:\Documents and Settings\fae>_
```

3. Type ping 192.168.1.1 and press [Enter]. If the link is OK, the line of “**Reply from 192.168.1.1:bytes=32 time<1ms TTL=255**” will appear.
4. If the line does not appear, please check the IP address setting of your computer.

For MacOs (Terminal)

1. Double click on the current used MacOs on the desktop.
2. Open the **Application** folder and get into **Utilities**.
3. Double click **Terminal**. The Terminal window will appear.
4. Type **ping 192.168.1.1** and press [Enter]. If the link is OK, the line of “**64 bytes from 192.168.1.1: icmp_seq=0 ttl=255 time=xxxx ms**” will appear.

```

Terminal — bash — 80x24
Last login: Sat Jan  3 02:24:18 on ttys1
Welcome to Darwin!
Vigor10:~ draytek$ ping 192.168.1.1
PING 192.168.1.1 (192.168.1.1): 56 data bytes
64 bytes from 192.168.1.1: icmp_seq=0 ttl=255 time=0.755 ms
64 bytes from 192.168.1.1: icmp_seq=1 ttl=255 time=0.697 ms
64 bytes from 192.168.1.1: icmp_seq=2 ttl=255 time=0.716 ms
64 bytes from 192.168.1.1: icmp_seq=3 ttl=255 time=0.731 ms
64 bytes from 192.168.1.1: icmp_seq=4 ttl=255 time=0.72 ms
^C
--- 192.168.1.1 ping statistics ---
5 packets transmitted, 5 packets received, 0% packet loss
round-trip min/avg/max = 0.697/0.723/0.755 ms
Vigor10:~ draytek$

```

5.4 Checking If the ISP Settings are OK or Not

Open **WAN>>Internet Access** page and then check whether the ISP settings are set correctly. Use the Connection Type drop down list to choose Static IP/DHCP/PPPoE/PPTP/L2TP/3G USB Modem for reviewing the settings that you configured previously.



WAN >> Internet Access

WAN IP Configuration

Connection Type	DHCP
-----------------	------

DHCP Settings

Router Name	Vigor2130	(The same as syslog's router name)
-------------	-----------	--------------------------------------

WAN Connection Detection

Mode	ARP
Ping IP	0.0.0.0

Clone MAC Address

Enable	<input type="checkbox"/>
--------	--------------------------

OK

For Static Users

1. Choose **Static IP** as the connection type.

WAN >> Internet Access

WAN IP Configuration

Connection Type	Static IP
-----------------	-----------

Static IP Settings

IP Address	172.16.3.102
Subnet Mask	255.255.0.0
Gateway IP Address	172.16.1.1
Primary DNS Server	168.95.1.1
Secondary DNS Server	0.0.0.0

WAN Connection Detection

Mode	ARP
Ping IP	0.0.0.0

Clone MAC Address

Enable	<input type="checkbox"/>
--------	--------------------------

OK

2. Check if **IP Address**, **IP Mask** and **IP Router** are set correctly (must identify with the values from your ISP).

For PPPoE Users

1. Choose **PPPoE** as the connection type.

WAN >> Internet Access

WAN IP Configuration

Connection Type	PPPoE
-----------------	-------

PPPoE Settings

Username	
Password	
Redial Policy	Connect on Demand
Idle Time out	
MTU Size	

WAN Connection Detection

Mode	Ping Detect
Ping IP	0.0.0.0

Clone MAC Address

Enable	<input type="checkbox"/>
--------	--------------------------

OK

2. Check if **Username** and **Password** are set correctly (must identify with the values from your ISP).

For PPTP/L2TP Users

1. Choose **PPTP/L2TP** as the connection type.

WAN >> Internet Access

WAN IP Configuration

Connection Type	PPTP
PPTP Settings	
Username	2130
Password	••••
Server Address	0.0.0.0
WAN IP Network Settings	Static IP
IP Address	192.168.1.5
Subnet Mask	255.255.0.0
Primary DNS Server	0.0.0.0
Secondary DNS Server	0.0.0.0
Redial Policy	Connect on Demand
Idle Time out	
MTU Size	
Clone MAC Address	
Enable	<input type="checkbox"/>

2. Check if **Username, Password, IP address, Subnet Mask** are entered with correct values that you **get from your ISP**.

5.5 Forcing Vigor Router into TFTP Mode for Performing the Firmware Upgrade

1. Press and hold the **Factory Reset** button. The system will power off and power on the Vigor Router.
2. Release the **Factory Reset** button when the ACT LED and its neighbor LED blink simultaneously.
There are different LED blinking methods in describing TFTP mode status:
Vigor2130: ACT LED & its neighbor LED blink simultaneously.
3. Change your PC IP address to 192.168.1.10.
4. Open **Firmware Upgrade Utility** and key in Router IP 192.168.1.1 manually.
5. Install **Router Tools** on one computer that connects to Vigor Router's LAN port.
6. Make sure the computer can ping Vigor's LAN IP. (Default IP is 192.168.1.1)
7. Run **Router Tools >> Firmware Upgrade Utility**.
8. Input Vigor's LAN IP manually or use the . . . button to select.
9. Indicate the firmware location.

Note: There are two firmware types. The *.rst* firmware format will make the configurations be back to default settings after upgrading firmware. The *.all* firmware format will remain the former configurations after upgrading firmware.

10. Input the Password if you have set one, then click **Send**.

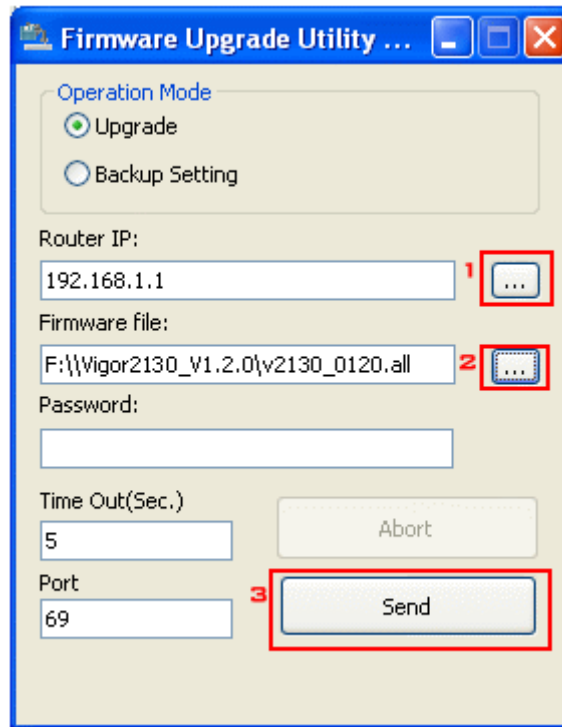

11. There is a bar showing the upgrading process.

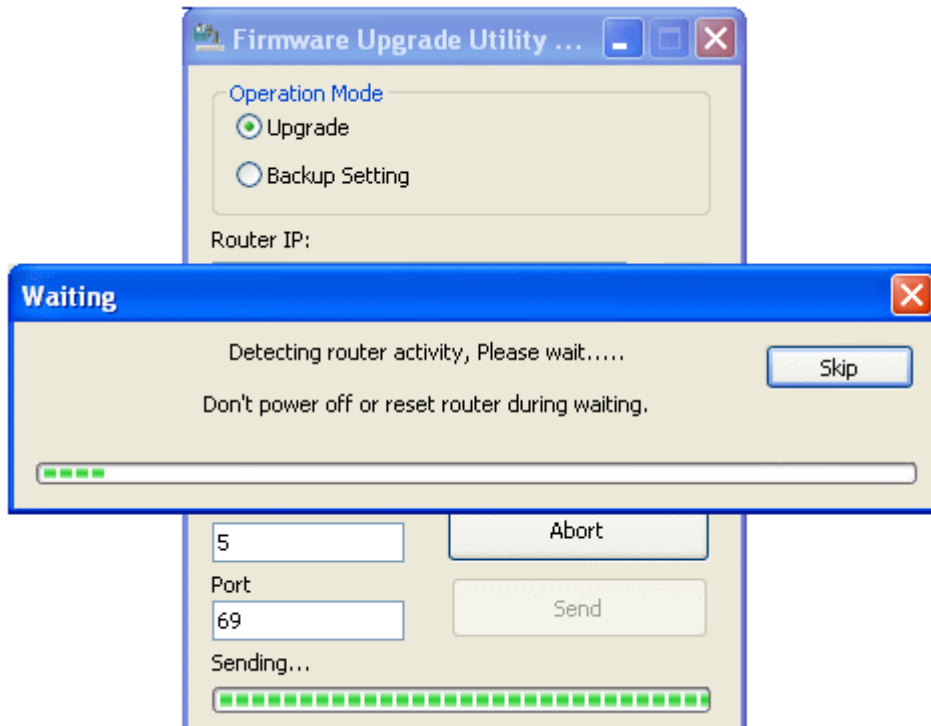

12. When the firmware upgrade is successful, the following window will pop up.

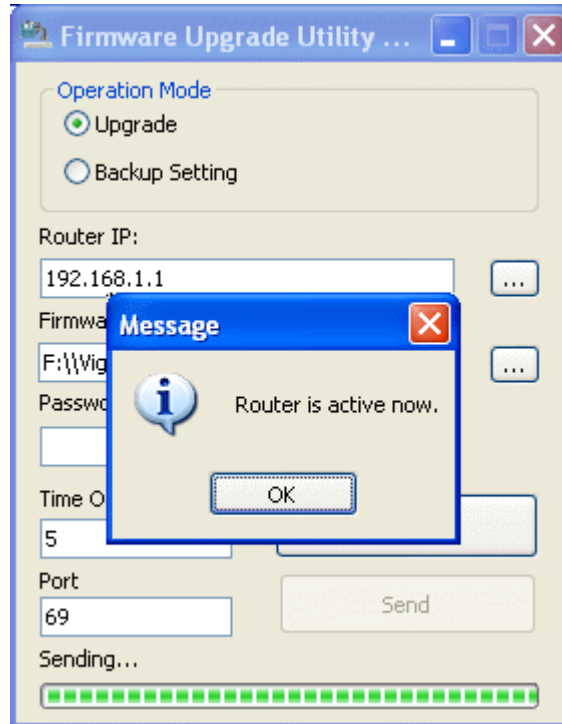

If the message of **Request Timeout. Transfer Abort !** appears, please check if the connection between the computer and the Vigor is active or not. And, if the message of **Incorrect/No file name. Transfer Abort !** appears, please check if the firmware you download is correct for your Vigor router.

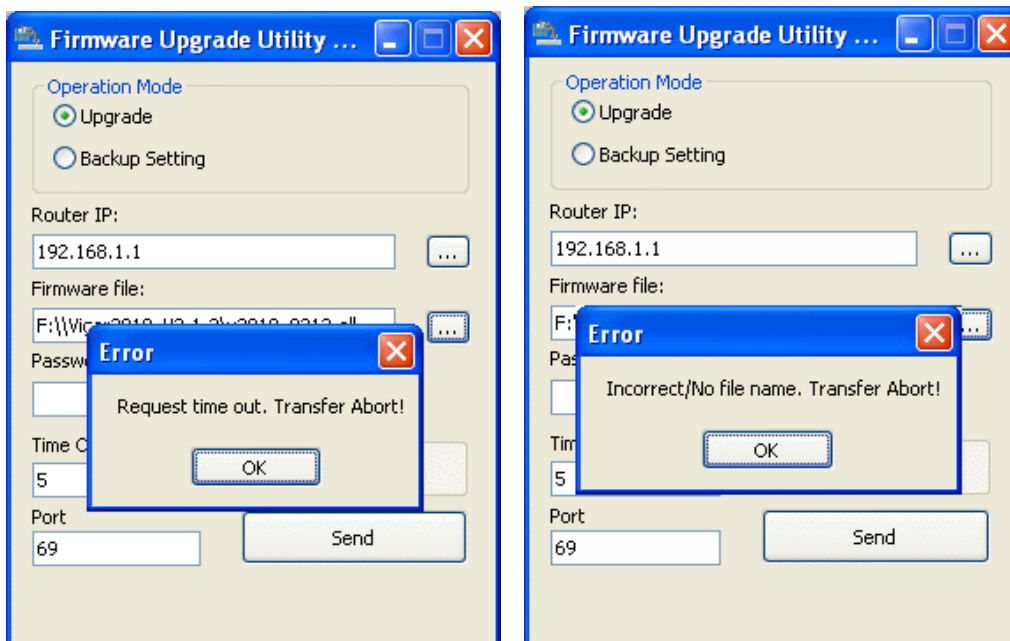

Note: Please turn off the Firewall protection while upgrading the firmware with Windows Vista. The Firewall function can be turned off via **Control Panel >> Security Center >> Firewall**.

5.6 Backing to Factory Default Setting If Necessary

Sometimes, a wrong connection can be improved by returning to the default settings. Try to reset the router by software or hardware.



Warning: After pressing **factory default setting**, you will lose all settings you did before. Make sure you have recorded all useful settings before you pressing.

Software Reset

You can reset the router to factory default via Web page.

Go to **System Maintenance** and choose **Reboot System** on the web page. The following screen will appear. Choose **Using factory default configuration** and click **OK**. After few seconds, the router will return all the settings to the factory settings.

System Maintenance >> Reboot System

Reboot System

Do You want to reboot your router ?

Using current configuration
 Using factory default configuration

Yes

No

Hardware Reset

While the router is running (ACT LED blinking), press the **Factory Reset** button and hold for more than 5 seconds. When you see the **ACT LED** blinks rapidly, please release the button. Then, the router will restart with the default configuration.

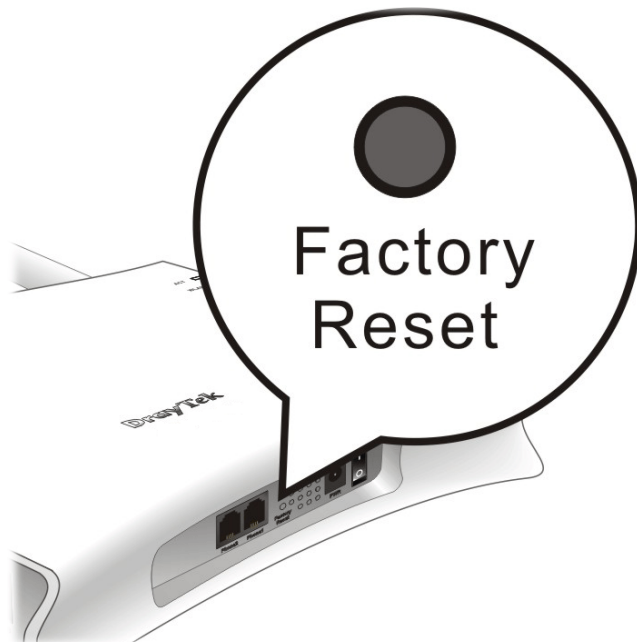

After restore the factory default setting, you can configure the settings for the router again to fit your personal request.

5.7 Contacting Your Dealer

If the router still cannot work correctly after trying many efforts, please contact your dealer for further help right away. For any questions, please feel free to send e-mail to support@draytek.com.